

Installation Manual: R-454B Outdoor Split-System Air Conditioner

YC4, XC4, RC4, YC3, XC3, RC3, YC6, XC6 and RC6 Series

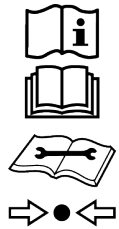

Refrigerant
Safety Group
A2L

 **CAUTION**

Risk of fire

This unit uses a mildly flammable (A2L) refrigerant. See [A2L refrigerant safety considerations](#) to ensure safe installation, operation, and servicing of this unit.

York International Corporation, 5005 York Drive, Norman, OK 73069

6411591-UIM-B-0824

Supersedes: 6411591-UIM-A-0324

2024-08-15

B

Contents

About the unit.....	5
Certification.....	5
DS Solutions App.....	5
Safety.....	6
Understanding safety symbols and instructions.....	6
Safety requirements.....	6
A2L refrigerant safety considerations.....	8
General.....	8
Room size requirements.....	9
Mechanical ventilation.....	11
Refrigerant equipment checks.....	11
Electrical devices checks.....	12
Detection of refrigerant.....	12
Wiring installation.....	13
Installation overview.....	15
Preparing for installation.....	16
Selecting a location for installation.....	16
Inspecting the unit.....	17
Understanding installation and operation limitations.....	18
.....	18
Meeting requirements for A2L equipment.....	18
Installing the outdoor unit.....	19
Setting the outdoor unit on the ground or on a roof.....	19
Mounting the outdoor unit on a wall.....	20
Installing the outdoor unit as a replacement unit.....	20
Installing the refrigerant piping.....	23
Installing the vapor and liquid lines.....	23
Installing the liquid line filter-drier.....	25
Braze the refrigerant lines and service valves.....	26
Installing the thermostatic expansion valve (TXV).....	27
Checking for refrigerant leaks.....	30
Evacuating the refrigerant lines and indoor coil.....	31
Releasing refrigerant into the system.....	32
Connecting the wiring.....	33
General information and grounding the unit.....	33
Completing the field power wiring connections.....	34
Completing the field control wiring connections.....	35
Control wiring.....	36
Charging the system.....	39
Measuring indoor airflow.....	40

- Determining the total system charge..... 41
- Charging the indoor TXV in subcooling mode..... 42
 - R-454B saturation properties.....42
- Optional cold weather charging..... 43
 - 43
- Starting up the system..... 44
- Instructing the user..... 45
 - Maintenance and repair.....45
 - Required procedures for A2L systems..... 46
 - Decommissioning..... 46
- Third-party trademarks notice.....47
- Wiring diagrams..... 48
- Start-up sheet..... 53

About the unit

Read all sections of this manual. Keep this manual and the manual for the matching indoor unit for future reference.

These outdoor condensing units are designed to connect to a matching indoor coil. They are shipped with a filter-drier that must be installed in the liquid line.

Units with quick-connect coupling connections are factory-charged with refrigerant to be matched with the appropriate pre-charged refrigeration piping and indoor coil.

Certification



Assembled at a facility with
an ISO 9001:2015-certified
Quality Management
System

DS Solutions App

Johnson Controls believes in empowering our customers with unit-specific information at all times. Download the Ducted Systems Solutions Mobile App (DS Solutions App), which is available through the App Store for iOS and Google Play for Android. Users can use the DS Solutions App to scan the QR code located on the rating plate that is unique to each unit and provides information specific to the product. Take advantage of the features available for all units: Nomenclature, Literature (Technical Guide, Installation Manual and Wiring Diagrams), Parts list, Product Registration, Claims Tracking, and more.



iOS



Android

Safety

It is important to understand the safety symbols used in this manual. Read safety information carefully and follow all safety requirements to ensure correct installation.

Understanding safety symbols and instructions



This is a safety alert symbol. When you see this symbol on labels or in manuals, be alert to the potential for personal injury.

Understand and pay particular attention to the signal words **DANGER**, **WARNING**, **CAUTION**, as well as the **NOTICE**, **Important**, and **Note** alerts.

DANGER indicates an **imminently** hazardous situation, which, if not avoided, will result in death or serious injury.

WARNING indicates a **potentially** hazardous situation, which, if not avoided, could result in death or serious injury.

CAUTION indicates a **potentially** hazardous situation, which, if not avoided may result in minor or moderate injury. It is also used to alert against unsafe practices and hazards involving only property damage.

NOTICE indicates information considered important, but not hazard-related, such as messages relating to property damage.

Important indicates information that is essential to complete a task or may result in damage to the device if not followed.

Note indicates something of special interest or importance. Notes can contain any type of information except safety information.

Safety requirements

WARNING

Incorrect installation may create a condition where the operation of the product could cause personal injury or property damage. Incorrect installation, adjustment, alteration, service, or maintenance can cause injury or property damage. Refer to this manual for assistance. For additional information, consult a qualified installer or service agency.

WARNING

Total system charge exceeding 3.9 lbs requires a refrigerant detection sensor.
Total system charge = outdoor unit + indoor coil charge adder + refrigerant piping adder

CAUTION

This product must be installed in strict compliance with the enclosed installation instructions and any applicable local, state, and national codes including but not limited to building, electrical, and mechanical codes.

 **CAUTION**

R-454B systems operate at lower pressures than R-410A systems. Do not use R-410A service equipment or components on R-454B equipment. Service equipment must be rated for R-454B.

NOTICE

These units are partial unit air conditioner, complying with partial unit requirements of this Standard, and must only be connected to other units that have been confirmed as complying to corresponding partial unit requirements of this Standard, UL 60335-2-40/CSA C22.2 No. 60335-2-40

NOTICE

To ensure a correct match for this outdoor product, refer to the current *Tabular Data Sheet* for the indoor equipment selected for the system application. If the indoor product model is not listed in the *Tabular Data Sheet* included with the outdoor unit, access the current version of the Tabular Data Sheet on the *Residential Equipment & Supplies* section at www.simplygettingthejobdone.com or scan the QR code provided on the outdoor unit rating plate.

A2L refrigerant safety considerations

CAUTION

You must read all of this section before installing this unit.

WARNING

Do not use means to accelerate the defrosting process or to clean, other than those recommended by the manufacturer.

The appliance shall be stored in a room without continuously operating ignition sources (for example, open flames, an operating gas appliance, or an operating electric heater).

Do not pierce or burn

Be aware that refrigerants may not contain an odor.

General

Item number	Safety consideration
1	Any appliance containing more than 4 lb in a refrigerating circuit must be constructed such that any refrigerant leak cannot stagnate in a way that would create a fire or explosion hazard.
2	Before beginning work on systems containing flammable refrigerants, safety checks are necessary to ensure that the risk of ignition is minimized. For repair to the refrigerating system, item 3 to item 7 below must be adhered to before conducting work on the system.
3	Work must be undertaken under a controlled procedure so as to minimize the risk of a flammable gas or vapor being present while the work is being performed.
4	Instruct all maintenance staff and others working in the local area on the nature of work being carried out. Avoid work in confined spaces.
5	The area must be checked with an appropriate refrigerant detector before and during work to ensure the technician is aware of potentially toxic or flammable atmospheres. Ensure that the leak detection equipment being used is suitable for use with all applicable refrigerants: non-sparking, adequately sealed, or intrinsically safe.
6	If conducting any hot work on the refrigerating equipment or any associated parts, you must have appropriate fire-extinguishing equipment on hand. Have a dry powder or CO ₂ fire extinguisher adjacent to the charging area.
7	If conducting work in relation to the refrigerating system that involves exposing any pipework, do not use any sources of ignition in such a manner that may lead to the risk of fire or explosion. All possible ignition sources, including cigarette smoking, must be kept sufficiently far away from the site of installation, repair, removal, and disposal, during which refrigerant might possibly be released to the surrounding space. Before conducting any work, survey the area around the equipment to ensure that there are no flammable hazards or ignition risks. Display "No Smoking" signs.

Item number	Safety consideration
8	Ensure the area is in the open or that it is adequately ventilated before opening the system or while conducting any hot work. The ventilation must safely disperse any released refrigerant and preferably expel it externally into the atmosphere.
9	Ensure that the sensor is not obstructed in any way.

Room size requirements

Table 1:

Item number	Safety consideration
1	If the unit must be installed in a residence with a total conditioned area less than what is determined to be the minimum from Table 2 , then that room must also not have any continuously operating open flames or other potential ignition sources. A flame-producing device may be present if that device is provided with an effective flame arrest.

Table 2: Minimum room area

System charge (lb-oz)	Minimum room area (ft ²)	Minimum total conditioned area (ft ²)	Minimum system airflow (CFM)
4-0	43	58	233
4-4	46	61	248
4-8	48	65	262
4-12	51	69	277
5-0	54	72	291
5-4	56	76	306
5-8	59	80	321
5-12	62	83	335
6-0	64	87	350
6-4	67	90	364
6-8	70	94	379
6-12	73	98	393
7-0	75	101	408
7-4	78	105	422
7-8	81	108	437
7-12	83	112	452
8-0	86	116	466
8-4	89	119	481
8-8	91	123	495
8-12	94	127	510
9-0	97	130	524
9-4	99	134	539
9-8	102	137	554

Table 2: Minimum room area

System charge (lb-oz)	Minimum room area (ft ²)	Minimum total conditioned area (ft ²)	Minimum system airflow (CFM)
9-12	105	141	568
10-0	107	145	583
10-4	110	148	597
10-8	113	152	612
10-12	115	155	626
11-0	118	159	641
11-4	121	163	656
11-8	124	166	670
11-12	126	170	685
12-0	129	173	699
12-4	132	177	714
12-8	134	181	728
12-12	137	184	743
13-0	140	188	758
13-4	142	192	772
13-8	145	195	787
13-12	148	199	801
14-0	150	202	816
14-4	153	206	830
14-8	156	210	845
14-12	158	213	860
15-0	161	217	874
15-4	164	220	889
15-8	167	224	903
15-12	169	228	918
16-0	172	231	932
16-4	175	235	947
16-8	177	239	962
16-12	180	242	976
17-0	183	246	991
17-4	185	249	1005
17-8	188	253	1020

Note:

- Minimum room area refers to the smallest air conditioned room on the lowest floor of the residence.
- Minimum total conditioned room area refers to the combined area of all air conditioned rooms in the residence.

If the system charge is not listed in the above table, use the formulas below to calculate the respective values:

- Minimum room area = system charge x 10.742
- Minimum total conditioned area = system charge x 14.458
- Minimum system airflow = system charge x 58.275

Mechanical ventilation

Table 3:

Item number	Safety consideration
1	If installing the unit in a residence below the determined total conditioned area from Room size requirements , then extra mechanical ventilation is required.

Refrigerant equipment checks

Table 4:

Item number	Safety consideration
1	Where electrical components are being changed, they must be fit for the purpose and to the correct specification. At all times, the manufacturer's maintenance and service guidelines must be followed. If in doubt, consult the manufacturer's technical department for assistance.
2	Apply the following checks to installations using flammable refrigerants: <ul style="list-style-type: none"> • Ensure the actual refrigerant charge is in accordance with the room size within which the refrigerant-containing parts are installed. • Ensure the ventilation machinery and outlets are operating adequately and are not obstructed. • Ensure marking on the equipment continues to be visible and legible. Correct any markings and signs that are illegible. • Install refrigerating pipe or components in a position where they are unlikely to be exposed to any substance that may corrode refrigerant-containing components, unless the components are constructed of materials that are inherently resistant to being corroded or are suitably protected against being corroded.

Electrical devices checks

Table 5:

Item number	Safety consideration
1	Repair and maintenance to electrical components must include initial safety checks and component inspection procedures.
2	If a fault exists that could compromise safety, then do not connect any electrical supply to the circuit until the fault is satisfactorily dealt with. If the fault cannot be corrected immediately but it is necessary to continue operation, use an adequate temporary solution. This must be reported to the owner of the equipment so all parties are advised.
3	Initial safety checks must include: <ul style="list-style-type: none"> • Ensure capacitors are discharged: take care to avoid the possibility of sparking. • Ensure no live electrical components and wiring are exposed while charging, recovering, or purging the system. • Ensure there is continuity of earth bonding.

Detection of refrigerant

Table 6:

Item number	Safety consideration
1	Under no circumstances shall potential sources of ignition be used in the searching for or detection of refrigerant leaks. Do not use a halide torch or any other detector using a naked flame.
2	The following leak detection methods are deemed acceptable for all refrigerant systems. <ul style="list-style-type: none"> • Electronic leak detectors may be used to detect refrigerant leaks but, in the case of flammable refrigerants, the sensitivity may not be adequate or may need re-calibration. Calibrate the detection equipment in a refrigerant-free area. Ensure that the detector is not a potential source of ignition and is suitable for the refrigerant used. Set leak detection equipment at a percentage of the LFL of the refrigerant and calibrate to the refrigerant employed. Ensure the appropriate percentage of gas with a maximum of 25% is confirmed. • Leak detection fluids are also suitable for use with most refrigerants but avoid the use of detergents containing chlorine as the chlorine may react with the refrigerant and corrode the copper pipework. Examples of leak detection fluids are bubble method and fluorescent method agents.
3	If a leakage of refrigerant is found that requires brazing, recover all of the refrigerant from the system or isolate the leakage by means of shut-off valves in a part of the system remote from the leak. Remove refrigerant according to the <i>Removal and evacuations</i> section of the outdoor unit's <i>Installation Manual</i> .

Wiring installation

NOTICE

Cap unused wiring connections.

NOTICE

The mitigation control board has a bank of DIP switches. For use with a JHE or JME air handler indoor model, both DIP switches must be in the 0 or off position. For use with all other indoor models, both DIP switches must be in the 1 or on position.

NOTICE

The mitigation control board has a G output and an A2L output. For Y81E, Z8ES, RL18, Y82E, Z8ET, Y82V, Z8VT, Y91E, Z9ES, RG19, Y92E, Z9ET, Y92V, Z9VT, Y9VV, Z9VV, and JMC indoor models, do not use the green G output wire. Instead, use the green/blk A2L and connect it to the G terminal on the indoor equipment.

See [Connecting the wiring](#) for specific information on connecting the wiring for the coil and the chosen indoor and outdoor units.

① **Note:** The 10-pin mitigation harness is included in the loose parts kit.

Figure 1: Mitigation control wiring

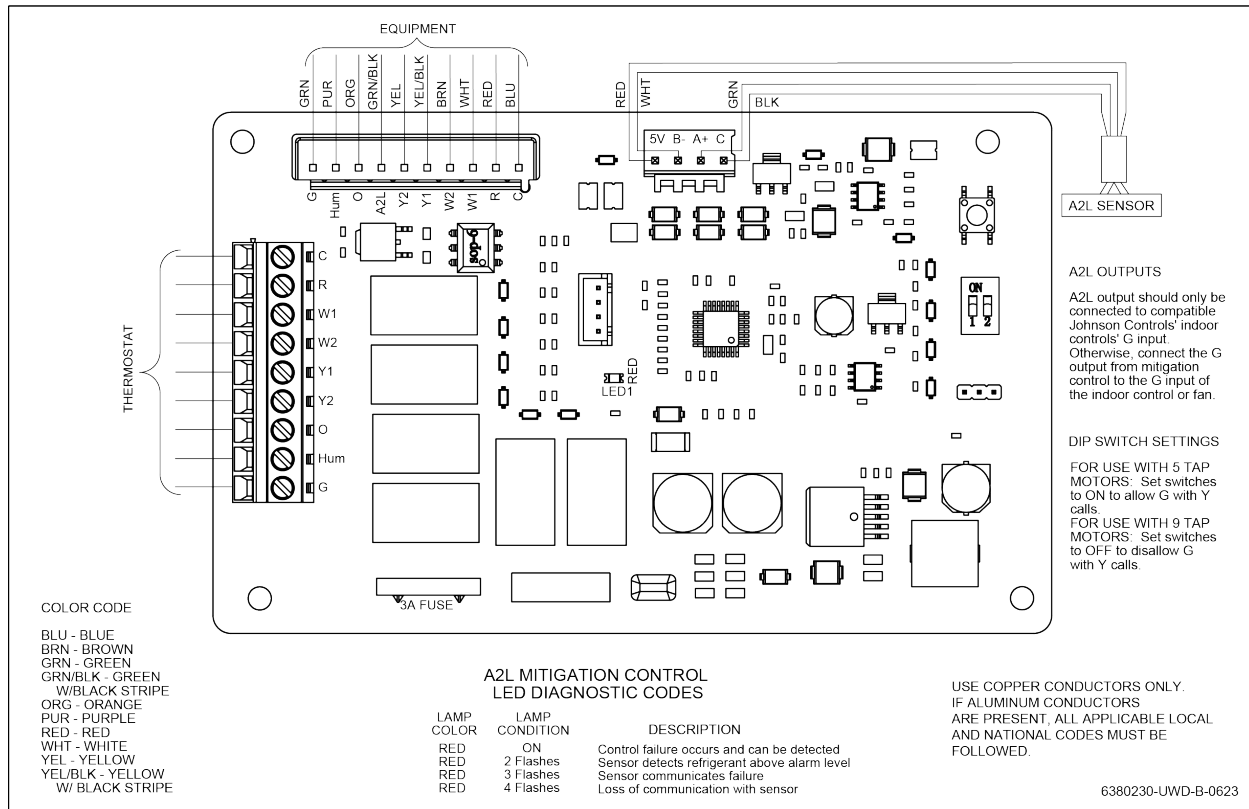

Figure 2: DIP switches in on position

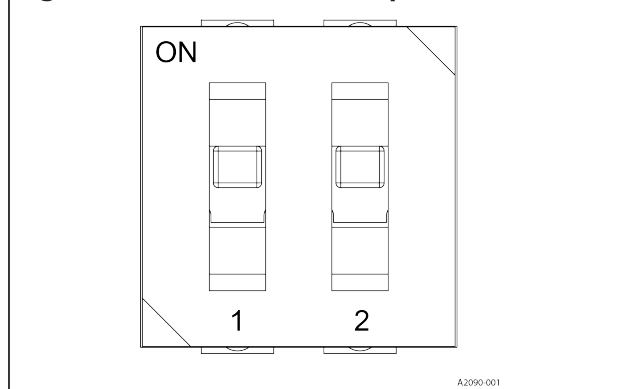
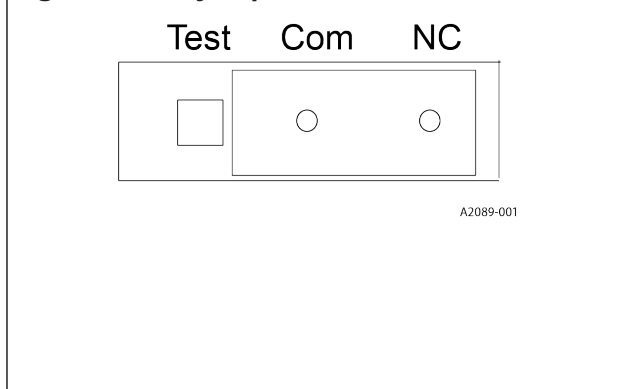

Figure 3: Test jumper



Field-testing the sensor

1. After wiring and configuring the system, provide a **Y** call for cooling.
2. Simulate an A2L leak by disconnecting the A2L sensor wire from the A2L control board, or else move the test jumper from **NC** (Normally Closed) to **Test**. Make sure to return the test jumper to **NC** once testing is complete. See .
3. After 15 s, verify that the call for the compressor is removed.
4. Verify that the **Y** output pin has no voltage and that the **G** output pin has 24 VAC.
5. Reinstall the sensor, then wait 5 min and verify that the system returns to cooling mode.
6. When the system is in standby mode, repeat the above test for a **W** call for heating.
7. When testing is complete, re-install the front cover on the control box.

Installation overview

Complete all of the stages outlined in [Installation overview](#). You may not need to perform tasks indicated with a dashed outline, depending on the specific installation.

Figure 4: Installation overview

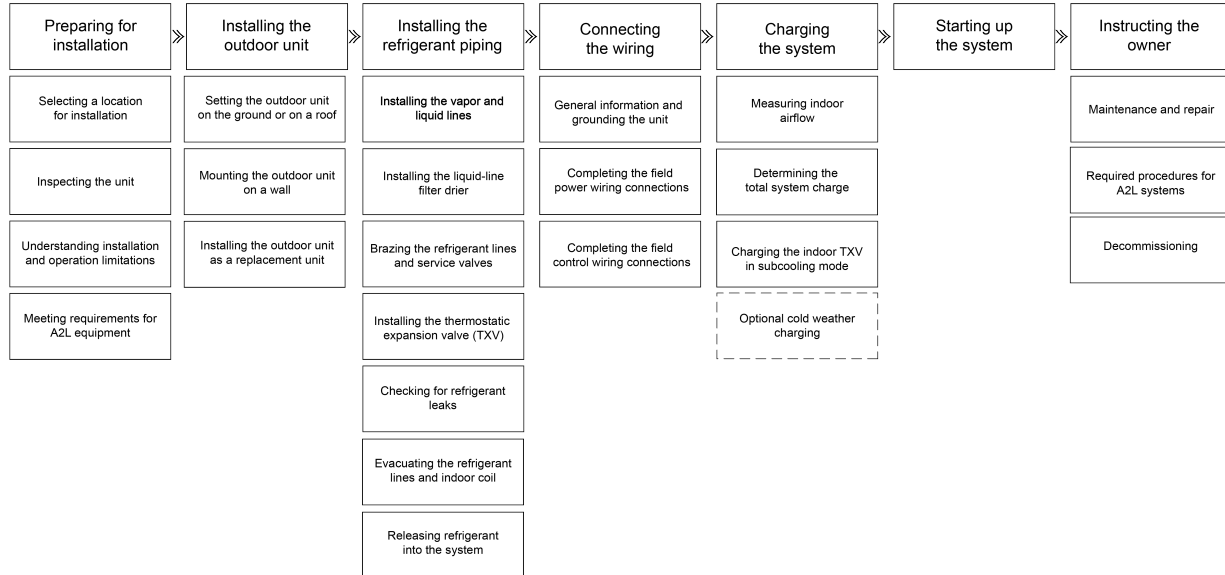

92144-001

Preparing for installation

Complete the necessary preparation before you begin the installation:

1. Visit the installation site to select a suitable location for the outdoor unit and plan the refrigerant piping system.
2. Inspect the outdoor unit.
3. Make sure that you are aware of the installation and operation limitations.
4. Familiarise yourself with the requirements for installing or servicing R-454B equipment and make sure you have all necessary equipment.

Selecting a location for installation

About this task:

Before starting the installation, you must select a suitable location for the outdoor unit. Observe all limitations and clearance requirements. You can install the outdoor unit on the ground, on a roof, or on a wall.

 **Note:** For more information about selecting a suitable location for the indoor unit, refer to the *Installation Manual* for the indoor unit.

WARNING

The outdoor unit must not be installed in an area where mud or ice could cause personal injury.

NOTICE

For multiple unit installations, units must be spaced a minimum of 24 in. (61 cm) apart (coil face to coil face).

 **Important:** Avoid the following places for installation where damage to the outdoor unit may occur:

- Where there is machine oil
- Coastal regions where the equipment is prone to atmospheric corrosion
- Near hot springs where the equipment is prone to sulfide gas corrosion
- In proximity to high-frequency or wireless equipment

Select a location for the outdoor unit that meets the following general requirements for installation:

- Is away from bedroom windows or other room windows where the sound of the unit operation might be objectionable.
- Provides adequate structural support for the unit.
- Allows sufficient clearance for air entrance to the outdoor coil, air discharge, and service access.
- Isolate the unit from rain gutters to avoid any possible wash out of the foundation.
- Allows you to elevate the unit sufficiently to prevent any blockage of the air entrances by snow in areas where snow may accumulate. Check the local weather bureau for the expected snow accumulation in your area.

- If the unit is installed on a hot sun-exposed roof or a paved ground area that is seasonally hot, the unit must be raised sufficiently above the roof or ground to avoid taking the accumulated layer of hot air into the outdoor unit.
- If the system is being installed during seasonally cold weather of 55°F or below, the preferred method is to weigh in the charge. For charging or checking the system charge at 55°F or below, see . An optional cold weather charging accessory kit is available to prevent the outdoor unit from taking in cold air below 55°F. The kit part number can be found in the list of accessory kits at <http://www.simplygettingthejobdone.com>.

Select a location for the outdoor unit that meets any requirements that are specific to the type of installation as outlined in [Table 7](#).

Table 7: Additional location requirements for each type of installation

Type of installation	Additional location requirements
Ground installation	<ul style="list-style-type: none"> • The location of the outdoor unit allows installation at ground level on a solid base that does not shift or settle, causing strain on the refrigerant lines and possible leaks. • The location of the outdoor unit allows for the condensate to drain directly on the ground in a safe area where public walkways will not be impacted.
Roof installation	<ul style="list-style-type: none"> • The structure is capable of supporting the total weight of the unit, including a base, lintels, and rails. You must use a base, lintels, and rails to minimize the transmission of sound or vibration to the structure. • The location of the outdoor unit allows sufficient space for the base. The base must not come in contact with the foundation or side of the structure because sound may transmit to the residence.
Wall-mounted installation	<ul style="list-style-type: none"> • Mounting the outdoor unit does not cause a loss of structural integrity. • The location of the outdoor unit ensures that there is minimal transmission of sound and vibration into the living space. • The outdoor unit can be accessed safely when mounted, for example, for servicing. • The location of the outdoor unit allows you provide adequate support for the base pan.

Inspecting the unit

1. Remove the shipping carton and inspect the unit immediately after receiving it for possible damage during transit.
2. If damage is evident, do the following:
 - a. Note the extent of any damage on the carrier's receipt.
 - b. Make a separate written request for the carrier's agent to inspect the unit.
 - c. Contact the local distributor for more information.

Understanding installation and operation limitations

Install the unit in accordance with all national, state, and local safety codes, and the following requirements:

- Observe the limitations for the indoor unit, coil, and appropriate accessories.
- Do not install the outdoor unit with any ductwork in the air stream. The outdoor fan is a propeller fan and is not designed to operate against any additional external static pressure.
- Observe the maximum and minimum conditions for operation to ensure that the system gives maximum performance and requires minimum service.
- **Important:** Do not operate the unit at outdoor temperatures below 55°F without an approved low ambient operation accessory kit installed.
- **Important:** The maximum allowable line length for this product is 80 ft.* Consult the Piping Application Guide (P/N 247077) for installations over the maximum allowable line length.

*This applies to all products except the YC618E2S11, and XC618E2S11 model which will only be installed up to a 75 ft line set maximum.

Table 8: Application limitations

Model	Ambient air temperature on outdoor coil (°F)		Air temperature on indoor coil (°F)	
	Minimum DB	Maximum DB	Minimum WB	Maximum WB
YC3/XC3/RC3	55	115	57	72
YC4/YC6/XC4/XC6/RC4/RC6/XC3 3 Phase	55	125	57	72

Meeting requirements for A2L equipment

Make sure that you have all necessary equipment before you begin the installation. You must adhere to the following requirements when installing or servicing R-454B equipment.

- Gauge sets, hoses, refrigerant containers, and the recovery system must be designed to handle the POE type oils and the pressures of R-454B.
- Manifold sets must be high side and low side with low side retard.
- All hoses must have a 700 psig service pressure rating.
- Electronic leak detectors can be used for detecting refrigerant leaks. For flammable refrigerants, check the sensitivity and potentially recalibrate the detector.
- Leak detection fluids are also suitable for use with most refrigerants. Avoid using detergents containing chlorine, as they can react with refrigerants and corrode copper pipework. Examples of leak detection methods include the bubble method and fluorescent agents.
- Recovery equipment, including refrigerant recovery containers, must be specifically designed to handle R-454B.
- Only use a TXV that is specifically designed for R-454B refrigerant.
- If an indirect refrigerating circuit is used, inspect the secondary circuit for refrigerant presence.
- Maintain visible and legible markings on the equipment. Illegible markings or signs should be corrected.
- Install refrigerant pipes and components in locations where they are unlikely to be exposed to corrosive substances, unless the components are made from corrosion-resistant materials or adequately protected against corrosion.

Installing the outdoor unit

There are three installation options for the outdoor unit: ground installation, roof installation, and wall-mounted installation. You must follow all requirements for the specific type of installation. See [Selecting a location for installation](#) for location requirements for ground, roof, and wall-mounted installation.

If you are installing the outdoor unit as a replacement for an existing unit, follow the procedure outlined in [Installing the outdoor unit as a replacement unit](#).

Setting the outdoor unit on the ground or on a roof

Before you begin:

Make sure that the location you have selected for the outdoor unit is suitable. See [Selecting a location for installation](#).

About this task:

For ground installation, you must use a strong, solid base, made of concrete or a similar material. For roof installation, you must use a base, lintels, and rails to minimize the transmission of sound or vibration to the structure. If site conditions require, elevate the unit above the base, for example, using riser legs, a stand, or snow legs.

1. Position the base in the pre-determined location, see [Selecting a location for installation](#).
2. Ensure that the compressor tie-down bolts remain tightened.
3. Install the unit in as level a position as possible while maintaining the clearances shown in [Figure 5](#) and [Figure 6](#).
4. Fasten the outdoor unit tightly to prevent noise.

Figure 5: Typical installation clearances

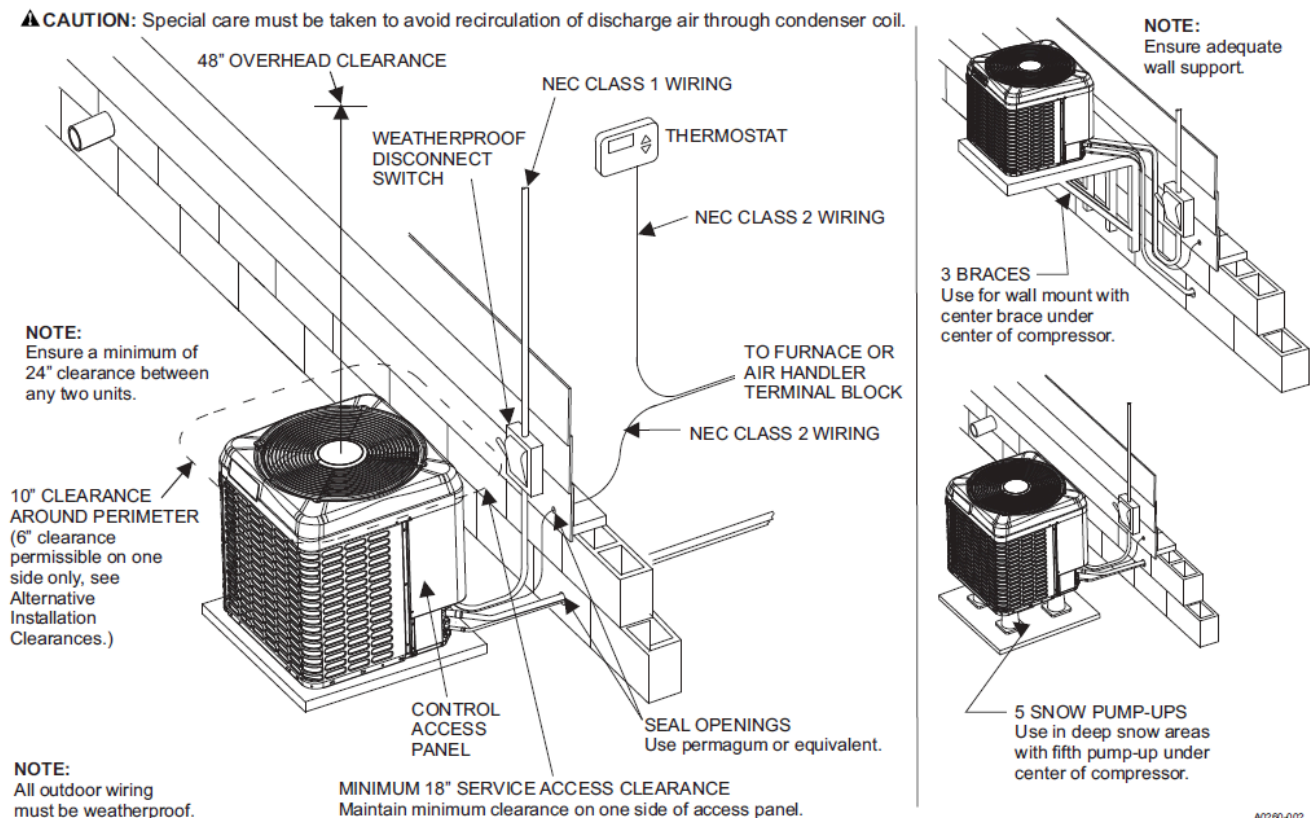
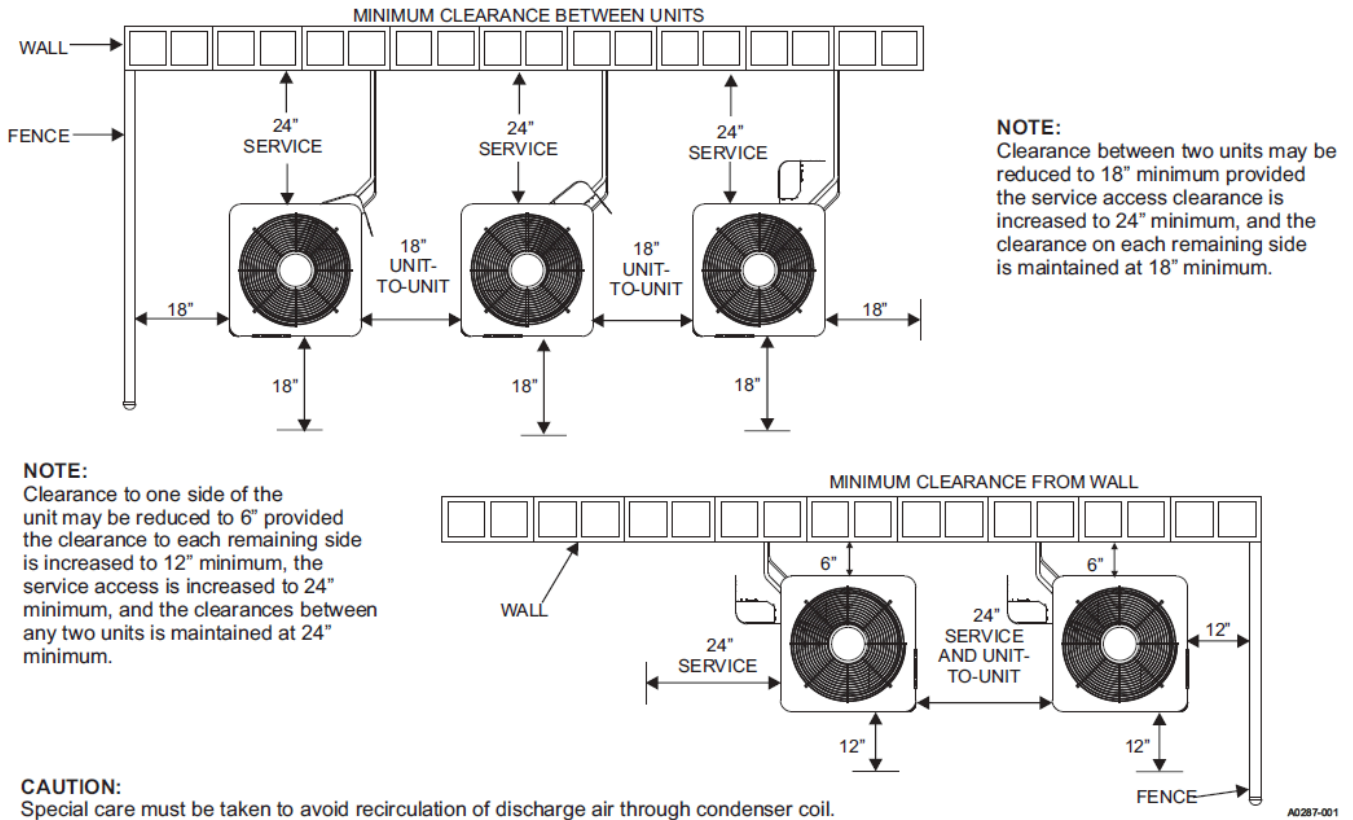

Figure 6: Alternative installation clearances



Mounting the outdoor unit on a wall

Before you begin:

On occasion, site conditions may require direct wall mounted brackets to be used to locate and support the outdoor unit. In these applications, address unit base pan support, structural integrity, safe access, and serviceability, as well as the possible sound and vibration transmission into the structure.

About this task:

When site conditions require you to mount the outdoor unit on a wall, you must use two direct wall mount brackets to support the outdoor unit. The wall mount brackets are field supplied. It is important to be aware that wall mounting is best served by a correctly engineered solution.

1. Make sure that the location you have selected for the outdoor unit is suitable. See [Selecting a location for installation](#).
2. Use two wall mount brackets to mount the outdoor unit on the wall.

Installing the outdoor unit as a replacement unit

About this task:

When installing this unit as a replacement for an existing R-454B unit, you must replace the outdoor unit, indoor coil, and metering device. Complete all of the steps outlined to ensure correct system operation and performance. Replace the refrigeration piping where possible.

 **WARNING**

Only replace components with parts specified by the manufacturer. Using other parts may lead to the ignition of refrigerant in the atmosphere in case of a leak.

 **WARNING**

Never install a suction-line filter drier in the liquid line of an R-454B system. Failure to follow this warning can cause a fire, injury, or death.

NOTICE

Never leave a suction-line drier in the system for longer than 50 h of run time.

1. Remove the existing outdoor unit.
2. Make sure that the location of the outdoor unit you are replacing is suitable for installing the outdoor unit. See [Selecting a location for installation](#).
3. Replace the indoor coil with an approved R-454B coil or outdoor unit combination with the appropriate metering device.
4. Install the outdoor unit. See [Setting the outdoor unit on the ground or on a roof](#) or [Mounting the outdoor unit on a wall](#).
5. Replace the refrigeration piping when replacing an R-410A unit with an R-454B unit to reduce cross-contamination of oils and refrigerants.

Table 9: Replacing refrigerant piping

Installation condition	Approach
You are replacing an outdoor unit that uses R-22, R-410A, or other refrigerant with an outdoor unit that uses R-454B refrigerant	Replace the refrigerant piping to reduce cross-contamination of oils and refrigerants. See . If replacing the refrigerant piping is not practical, take the following precautions: 1. Inspect the refrigeration piping for kinks, sharp bends or other restrictions, and for corrosion. 2. Determine if there are any low spots which might be serving as oil traps. 3. Flush the refrigeration piping with a commercially available flush kit to remove as much of the existing oil and contaminants as possible. 4. Install a suction line filter-drier to trap any remaining contaminants, and remove after 50 h of operation.
You are replacing the outdoor unit because of a compressor burnout	Replace the refrigerant piping or, at a minimum, thoroughly flush the refrigerant piping with a commercially available flush kit.

6. If the outdoor unit is being replaced due to a compressor burnout, then the installation of a 100% activated alumina suction-line filter-drier in the suction-line is required, in addition to the field-installed biflow liquid-line drier. Take the following steps:
- Operate the system for 10 h. Monitor the suction drier pressure drop.
 - If the pressure drop exceeds 3 psig, replace both the suction-line and liquid-line driers.
 - After a total of 10 h runtime where the suction-line pressure drop has not exceeded 3 psig, replace the liquid-line drier, and remove the suction-line drier.

Installing the refrigerant piping

To install the refrigerant piping correctly, you must do the following:

1. Install the vapor line and liquid line.
2. Install a liquid-line filter drier on the liquid line.
3. Braze the refrigerant lines and service valves.
4. Install the thermostatic expansion valve (TXV).
5. Check the refrigerant system for leaks.
6. Evacuate the refrigerant lines and the indoor coil.
7. Release refrigerant into the system.

Installing the vapor and liquid lines

About this task:

CAUTION

When installing refrigerant piping through the wall, keep the piping capped to prevent debris from entering. Do not place the pipe directly on the ground.

CAUTION

This system uses R-454B refrigerant, which operates at lower pressures than R-410A. No other refrigerant may be used in this system. Gauge sets, hoses, refrigerant containers, and the recovery system must be designed to handle R-454B. If you are unsure, consult the equipment manufacturer.

WARNING

Never install a suction-line filter-drier in the liquid line of an R-454B system. Failure to follow this warning can cause a fire, injury or death.

- **Important:** For long-line applications, you must install interconnecting lines over 100 ft with liquid-line solenoid. Refer to the *Piping Application Guide* for more information.

To install the vapor and liquid lines, do the following:

- Connect the outdoor unit to the indoor coil using field-supplied refrigerant grade (ACR) copper tubing that is internally clean and dry. You must install units with only the tubing sizes for approved system combinations as specified in the *Tabular Data Sheet*. The charge given is applicable for total tubing lengths up to 15 ft (4.57 m).
- Install the refrigerant lines with as few bends as possible. Make sure not to damage the couplings or kink the tubing. Use clean hard-drawn copper tubing where no appreciable amount of bending around obstruction is necessary. If you must use soft copper, make sure to avoid sharp bends that may cause a restriction.

- Install the refrigerant lines so that they do not obstruct service access to the coil, indoor unit, or filter.
- Isolate the refrigerant lines to minimize noise transmission from the equipment to the structure.
- Make sure that the vapor line is insulated with a minimum of 1/2 in. foam rubber insulation such as Armaflex or an equivalent. Make sure that the liquid line is insulated if it may be exposed to direct sunlight, high temperatures, or excessive humidity.
- Tape and suspend the refrigerant lines correctly. Do not allow tube metal-to-metal contact. See [Figure 7](#).

Figure 7: Installation of vapor line

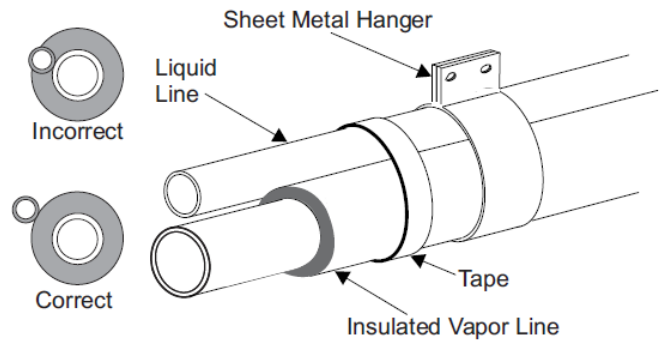

- Use PVC piping as a conduit for all underground installations as shown in [Figure 8](#). Keep buried lines as short as possible to minimize the build up of liquid refrigerant in the vapor line during long periods of shutdown.

Figure 8: Underground installation

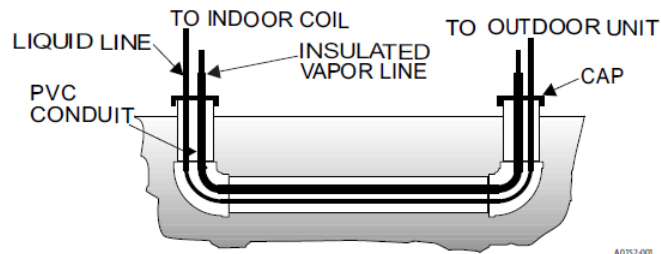

- Pack fiberglass insulation and a sealing material such as permagum around refrigerant lines where they penetrate a wall to reduce vibration and retain some flexibility.

Installing the liquid line filter-drier

About this task:

You must install an R-454B bi-flow liquid-line filter drier external to the outdoor unit. The indoor unit must be in place before you install the field-supplied R-454B liquid-line filter drier.

NOTICE

Using a larger than specified line size could result in oil return problems. Using too small a line results in loss of capacity and other problems caused by insufficient refrigerant flow. Horizontal refrigerant vapor lines between the indoor unit and the outdoor unit must slope towards the outdoor unit at approximately 1/8 in/ft to facilitate sufficient oil return.

To install the liquid-line filter drier, do the following:

1. Find a suitable location on the liquid line near the indoor unit.
2. Install the liquid-line filter drier in accordance with the installation instructions for the liquid-line filter drier.

Brazing the refrigerant lines and service valves

About this task:

It is important to take the necessary precautions for brazing the refrigerant lines and service valves. All outdoor unit and indoor coil connections are copper-to-copper and you must braze them with a phosphorous-copper alloy material such as Silfos-5 or equivalent. **Do not use soft solder.** These outdoor units have reusable service valves on both the liquid and vapor connections. The total system refrigerant charge is retained within the outdoor unit during shipping and installation. The reusable service valves are provided to evacuate and charge as outlined in this manual. You can avoid serious service problems by taking adequate precautions to ensure an internally clean and dry system.

CAUTION

The indoor coil is under inert gas pressure. Relieve pressure from the coil by depressing the Schrader core at the end of the suction manifold stub out. Dry nitrogen must always be supplied through the tubing while it is being brazed because the temperature required is high enough to cause oxidation of the copper, unless an inert atmosphere is provided. The flow of dry nitrogen must continue until the joint cools. Always use a pressure regulator and safety valve to insure that only low pressure dry nitrogen is introduced into the tubing. Only a small flow is necessary to displace air and prevent oxidation.

CAUTION

Do not install any coil in a furnace which is to be operated during the heating season without attaching the refrigerant lines to the coil. The coil is under pressure which must be released to prevent excessive pressure build-up and possible coil damage.

CAUTION

Do not connect manifold gauges unless trouble is suspected. Approximately 3/4 oz of refrigerant is lost each time a standard manifold gauge is connected.

WARNING

Never attempt to repair any brazed connections while the system is under pressure. Personal injury could result.

Take the following precautions when brazing the service valves:

- Wrap a wet rag around the service valve to prevent heat damage, as shown in [Figure 9](#).
- Protect items such as painted surfaces and insulation during brazing.
- After brazing, cool the joint with a wet rag.

WARNING

This is not a backseating valve. The service access port has a valve core. Opening or closing the valve does not close the service access port. If the valve stem is backed out past the chamfered retaining wall, the O-ring can be damaged, causing leakage or system pressure that could force the valve stem out of the valve body, possibly causing personal injury.

Figure 9: Brazing the service valves

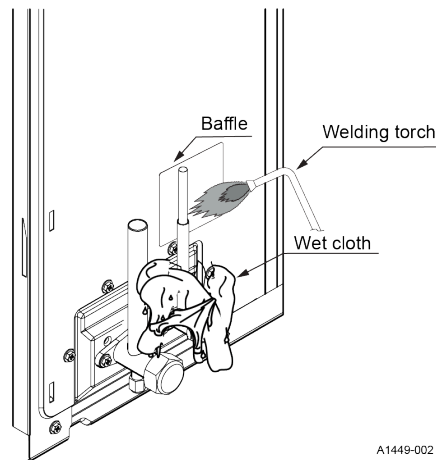

To braze the refrigerant lines and service valves, do the following:

1. Remove the cap and Schrader core from both the liquid and vapor service valve service ports at the outdoor unit.
2. Connect low pressure nitrogen to the liquid line service port.
3. Braze the liquid line to the liquid valve at the outdoor unit. Ensure to wrap the valve body with a wet rag. Allow the nitrogen to continue flowing.
4. Carefully remove the plugs from the liquid and vapor connections at the indoor coil.
5. Braze the liquid line to the indoor coil liquid connection. Nitrogen should be flowing through the indoor coil.
6. Slide the grommet away from the vapor connection at the indoor coil. Braze the vapor line to the indoor coil vapor connection. After the connection has cooled, slide the grommet back into its original position.
7. Protect the vapor valve with a wet rag and braze the vapor line connection to the outdoor unit. The nitrogen flow should be exiting the system from the vapor service port connection. After this connection has cooled, remove the nitrogen source from the liquid fitting service port.
8. Replace the Schrader core in the liquid and vapor valves.

Installing the thermostatic expansion valve (TXV)

About this task:

This is a basic overview of the procedure, for detailed instructions, refer to the *Installation Manual* accompanying the TXV kit and the indoor coil. Install the TXV kit as follows:

- **Important:** Refer to the *Technical Guide* or *Tabular Data Sheet* for the unit to determine the correct TXV kit to use on this product.

NOTICE

To prevent moisture and contaminants from entering the system, the coil must not be open to atmosphere for extended periods of time. If the coil cannot be brazed into the refrigeration system during a routine installation period, the ends must be temporarily closed or plugged. For a short term delay, use masking tape over the ends of the copper tubing to close the tube from the air. For a longer term delay, use plugs or caps. There is no need to purge the coil if this procedure is followed.

1. Relieve the holding charge by depressing the Schrader valve core on the suction manifold stub out.
2. When the holding charge is completely discharged, loosen and remove the Schrader valve core.
3. Place a backup wrench on the distributor, then loosen and remove the brass distributor nut. Retain the brass nut for use on the liquid line. Keep the PTFE washer in place and discard the sealing disk.
4. Install the TXV onto the distributor assembly with the supplied fittings. Ensure the PTFE washer is seated in the distributor. Hand tighten and turn an additional quarter turn to seal. See [Figure 10](#).

 **Note:** Do not overtighten the fittings.

CAUTION

Do not over-tighten. Do not use slip joint pliers. This distorts the aluminum distributor and the brass fitting, potentially causing leaks.

5. Slide the nut removed in Step 3 over the supplied liquid line. Place the supplied PTFE washer from the TXV kit in place on the TXV and install the liquid line to the top of the TXV. Adjust the distributor assembly so the liquid line aligns with the hole in the access panel. See [Figure 10](#). Hand tighten the liquid line and apply an additional quarter turn to seal.

CAUTION

The Schrader valve core **must not** be installed into the suction line TXV equalizer line fitting. Poor system performance or system failure could result.

Figure 10: TXV installation

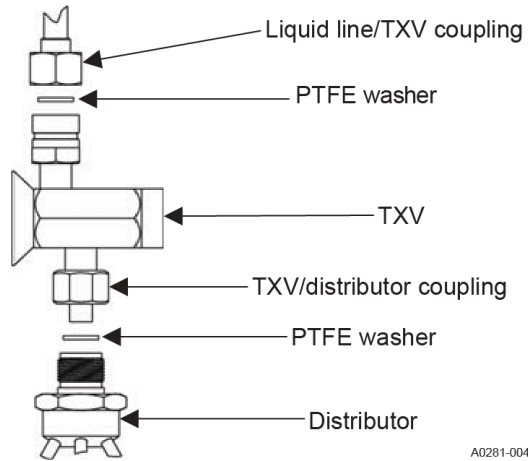

6. Install the TXV equalizer line onto the vapor line by hand tightening the 1/4 in. SAE coupling nut to the equalizer fitting and apply an additional third turn to seal. See [Figure 11](#).

CAUTION

Mount the TXV temperature sensing bulb after the vapor line is brazed and sufficiently cooled. Failure to use a suction-line split grommet may result in TXV failure.

Figure 11: TXV bulb and equalizer line installation

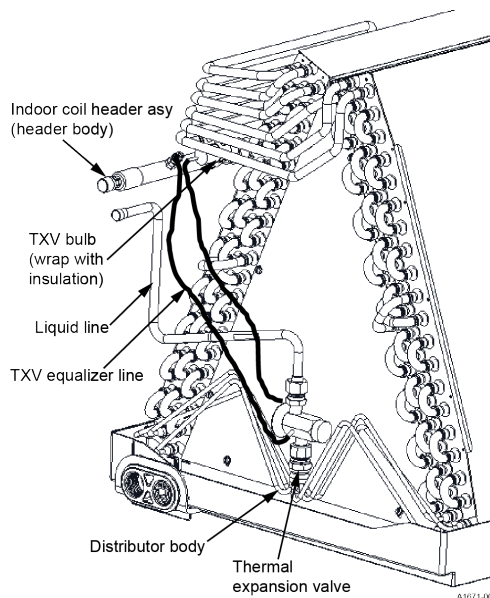
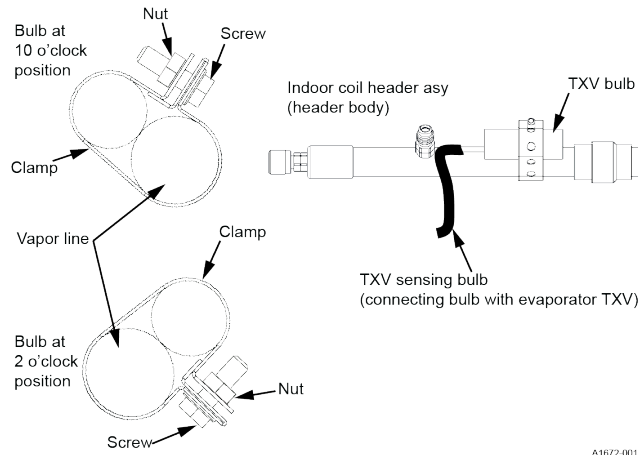

Figure 12: Correct bulb location for TXV



CAUTION

Outdoor unit model numbers ending with an H have a factory installed hard start kit which is required when a TXV kit is installed. Outdoor unit model numbers with no H ending do not require a hard start kit unless local regulations dictate it.

7. Route the temperature sensing bulb tube for the TXV toward the vapor line header and the TXV equalizer tube connection port on the vapor line header.
8. Install the TXV bulb to the vapor line near the TXV equalizer tube connection port, using the bulb clamps supplied with the TXV assembly. Ensure that the bulb makes maximum contact. See [Figure 11](#) and [Figure 12](#) and adhere to the following:
 - a. Install the TXV bulb on the vapor line suction header near the TXV equalizer tube connection port. Ensure that the bulb is installed at a 10 o'clock or 2 o'clock position.
 - b. Insulate the TXV bulb using the thermal insulation provided to protect it from the effect of the surrounding ambient temperature. Cover the bulb completely to insulate it.

What to do next:

After the refrigerant piping is installed, leak test the system.

Checking for refrigerant leaks

About this task:

NOTICE

Pressurize the refrigerant piping and the indoor coil to 250 psig with dry nitrogen and leak test with a bubble type leak detector. Then release the nitrogen charge.

Do not use the system refrigerant in the outdoor unit to purge or leak test.

1. Pressurize the refrigerant piping and the indoor coil to 250 psig with dry nitrogen.

2. Leak test all refrigerant piping connections including the service port flare caps to be sure they are leak tight. Do not over-tighten the refrigerant piping connections: tighten between 40 in-lb and 60 in-lb maximum.
3. Release the nitrogen charge.
4. If refrigerant leaks are present, repair the leaks and repeat Step 1 to Step 4 as needed until the testing indicates that no refrigerant leaks are present.

Evacuating the refrigerant lines and indoor coil

About this task:

Evacuate the system to 500 microns or less. If a leak is suspected, leak test with dry nitrogen to locate the leak. Repair the leak and test again.

To verify that the system has no leaks, do the following steps:

1. Close the valve to the vacuum pump suction to isolate the pump and hold the system under vacuum.
 2. Watch the micron gauge for a few minutes.
 - a. If the micron gauge indicates a steady and continuous rise, it is an indication of a leak.
 - b. If the gauge shows a rise, then levels off after a few minutes and remains fairly constant, it is an indication that the system is leak free but still contains moisture and may require further evacuation if the reading is above 500 microns.
- ① **Note:** If compressors or compressor oils are to be removed, ensure that they have been evacuated to an acceptable level to make certain that flammable refrigerant does not remain within the lubricant. The compressor body shall not be heated by an open flame or other ignition sources to accelerate this process. When oil is drained from a system, it must be carried out safely.

CAUTION

Ensure that the outlet for the vacuum pump is not near potential ignition sources, and have ventilation available.

What to do next:

Recover the refrigerant and adhere to the following rules:

- Ensure that the recovery equipment is in good working order and suitable for recovering flammable refrigerants.
- Always recover the refrigerant charge into the correct recovery cylinders.
- Ensure that cylinders are labeled for the recovered refrigerant, and they have pressure-relief valves and working shut-off valves.

Releasing refrigerant into the system

Before you begin:

Make sure that you have checked the refrigerant system for leaks and evacuated the refrigerant lines and indoor coil before releasing the refrigerant charge into the system. See [Checking for refrigerant leaks](#) and [Evacuating the refrigerant lines and indoor coil](#).

About this task:

To release the refrigerant charge into the system, follow these steps:

1. Open the liquid line service valve first.
2. When the system pressures have equalized, open the vapor line service valve by removing the valve caps and turning the valve counterclockwise using a hex-head wrench.
3. If the service valve is a ball valve, use an adjustable end wrench to turn the valve stem one-quarter turn counterclockwise to open. Do not overturn or the valve stem may break or become damaged. See .
4. Replace the service valve cap finger tight, then tighten an additional 1/12 turn (1/2 hex flat). Replace the cap to prevent leaks.
5. See for checking and recording system charge.

Connecting the wiring

To connect the wiring correctly, you must do the following:

1. Observe the general information and grounding information.
2. Install the field connections power wiring.
3. Install the field connections control wiring.

See for the outdoor unit wiring diagrams.

General information and grounding the unit

Before you begin:

Before you connect the wiring for the outdoor unit, note the information below.

About this task:

NOTICE

A flexible electrical connection must be installed in order to use the swing away function of the control box. A rigid electrical connection requires the wiring to be disconnected in order to swing the control box open.

CAUTION

All field wiring must only use copper conductors and be in accordance with Local, National, Fire, Safety and Electrical Codes. This unit must be grounded with a separate ground wire in accordance with the above codes.

- The control box cover is held in place with three screws, one screw in each lower corner and one screw at the top center post. The control box can swing open by removing the screw from the center of each side of the control box and allowing the control box to lower an inch into a pivotal position.
- The control box can then swing open from the left by rotating on the right side pivots for easy service of refrigeration components. If no wiring is in or routed through the control box, it can be removed from the unit by lifting slightly, tilting the top hinge out, and lifting the bottom hinge out. During the installation, route the low voltage wiring for the thermostat along the flexible line voltage electrical connection to help facilitate the swing away feature of the control box. See [Figure 13](#).
- Check the electrical supply to ensure it meets the values specified on the unit nameplate and wiring label.
- Power wiring, control (low voltage) wiring, disconnect switches, and over current protection must be supplied by the installer. Wire size must be sized following NEC requirements.
- The complete connection diagram and schematic wiring label is located on the inside surface of the unit service access panel.

Figure 13: Outdoor unit swing away control box

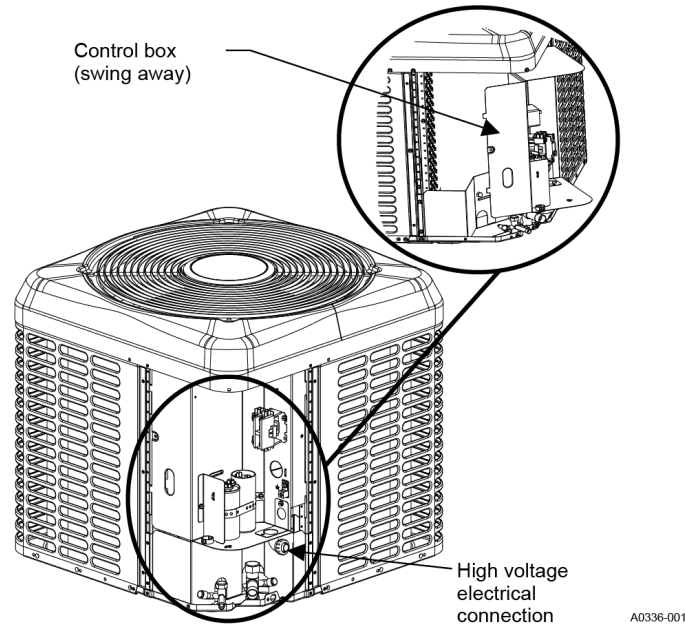

Completing the field power wiring connections

1. Install the correct size weatherproof disconnect switch outdoors and within sight of the unit.
2. Remove the screws at the top and sides of the corner cover.
3. Slide the control box cover down and remove from unit.
4. Run power wiring from the disconnect switch to the unit.
5. Route wires from disconnect through power wiring exit provided and into the unit control box as shown in [Figure 13](#), [Figure 14](#), and [Figure 15](#).
6. Install the correct size time-delay fuses or circuit breaker, and make the power supply connections.

Figure 14: Outdoor unit control box (single-phase - smaller base)

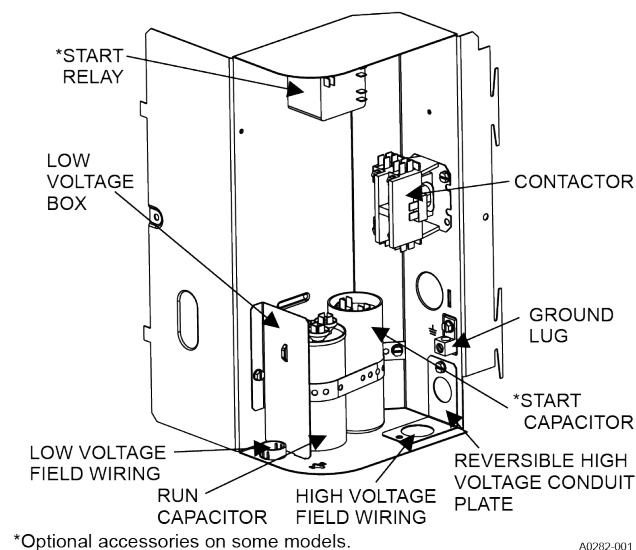

Figure 15: Outdoor unit control box (single-phase - larger base)

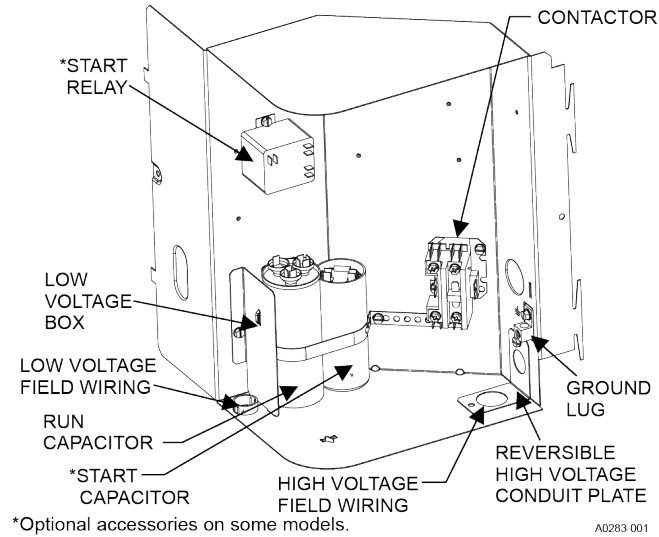
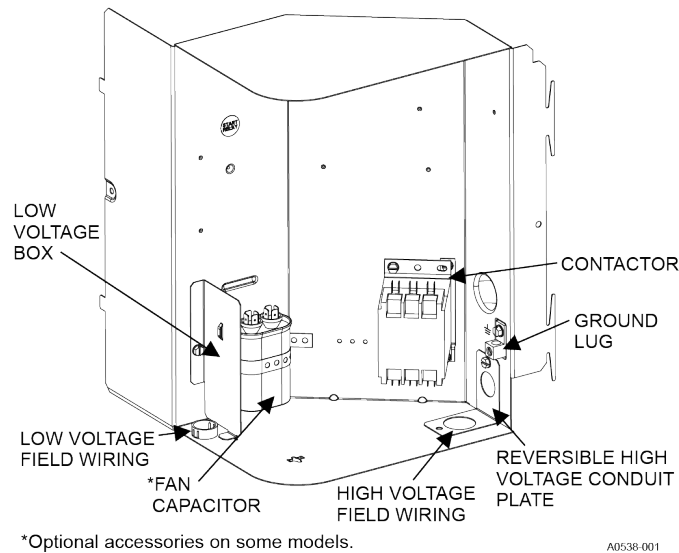

Figure 16: Outdoor unit control box (three-phase - larger base)



Completing the field control wiring connections

1. Route low voltage wiring into bottom of control box as shown in [Figure 14](#) or [Figure 15](#). Make low voltage wiring connections inside the low voltage box as shown in [Figure](#) .
2. The complete connection diagram and schematic wiring label is located on the inside surface of the unit service access panel.
3. Replace the control box cover removed in Step 2 of the procedures.
4. All field wiring to be in accordance with national electrical codes (NEC) or local city codes.

NOTICE

A Start Assist Kit is available and recommended for long refrigerant piping applications or in areas of known low voltage problems. The kit may be required when a TXV is used (refer to the *Tabular Data Sheet* to determine if applicable).

5. Mount the thermostat about 5 ft above the floor, where it is exposed to normal room air circulation. Do not place it on an outside wall or where it is exposed to the radiant effect from exposed glass or appliances, drafts from outside doors or supply air grilles.
6. Route the 24 V control wiring (NEC Class 2) from the outdoor unit to the indoor unit and thermostat.

NOTICE

To eliminate erratic operation, seal the hole in the wall at the thermostat with permagum or equivalent to prevent air drafts affecting the operation of the thermostat.

NOTICE

Check that cabling will not be subject to wear, corrosion, excessive pressure, vibration, sharp edges, or any other adverse environmental effects. During the check, consider the effects of aging or continual vibration from sources such as compressors or fans.

Control wiring

Figure 17: Control wiring - standard ECM air handler and standard single-stage air conditioner - conventional wiring

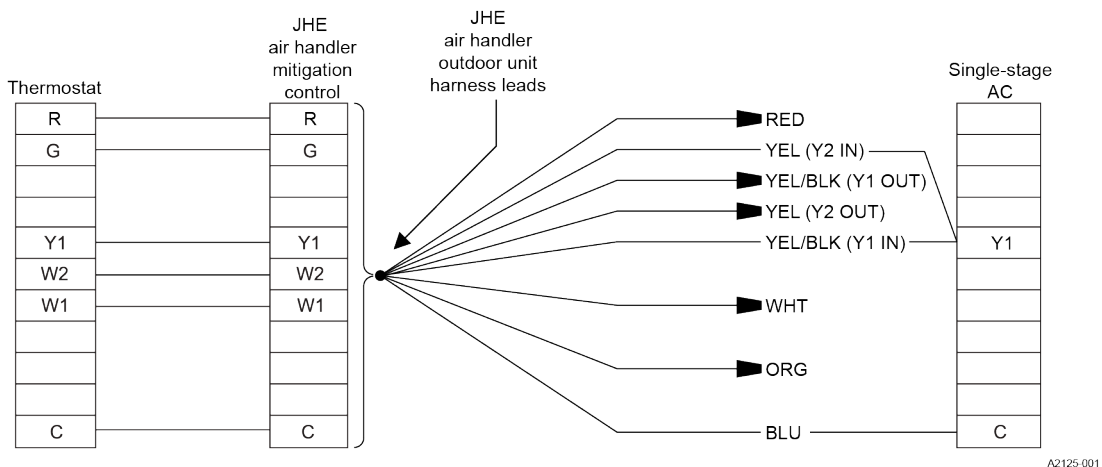
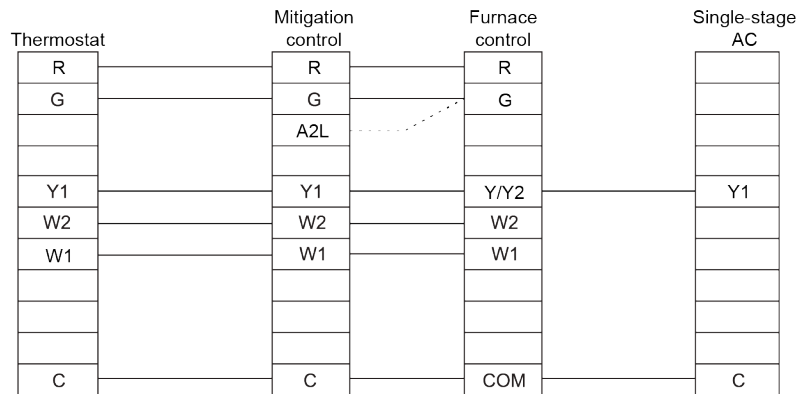
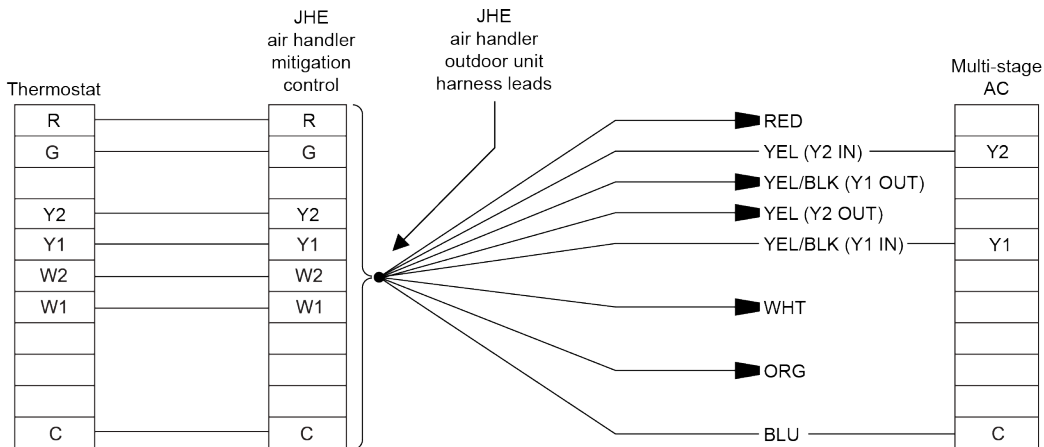

Figure 18: Control wiring - standard ECM gas furnace and standard single-stage air conditioner - conventional wiring



A2126-001

Figure 19: Control wiring - standard ECM air handler and standard multi-stage air conditioner - conventional wiring



A2116-001

Figure 20: Control wiring - standard ECM gas furnace and standard multi-stage air conditioner - conventional wiring

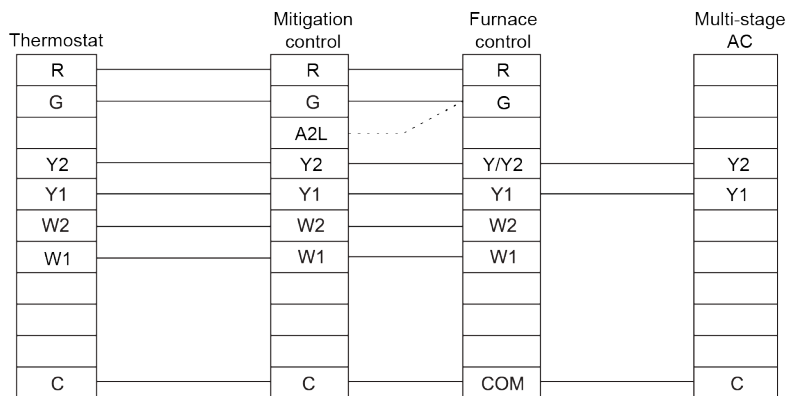

A2117-001

Note:

- YEL = Y1 (24V 1st stage compressor)
- YEL/RED = Y2 (24V 2nd stage compressor)
- BLU = 24V common

Charging the system

Before you begin:

NOTICE

For cold weather charging of the system at temperatures of 55°F or below, see the [Optional cold weather charging](#) procedures near the end of this section.

CAUTION

Do not leave the system open to the atmosphere.

WARNING

Do not attempt to pump the total system charge into the outdoor unit for maintenance or service. This may cause damage to the compressor or other components. Recover and weigh the system charge into an appropriate recovery cylinder for any instances requiring evacuation.

WARNING

Do not attempt to pump more than the factory charge and an additional 15 ft line charge into a tube and fin outdoor unit for maintenance or service. This can cause damage to the compressor or other components.

CAUTION

Refrigerant charging must only be carried out by a qualified air conditioning contractor.

CAUTION

Compressor damage will occur if system is incorrectly charged. On new system installations, charge the system as specified in the *Tabular Data Sheet* for the matched coil and follow guidelines in this manual.

The factory charge in the outdoor unit includes enough charge for the unit, 15 ft (4.6 m) of interconnecting refrigerant piping, and the smallest indoor coil match-up. Some indoor coil matches may require additional charge. Refer to the *Tabular Data Sheet* for charge requirements.

To ensure that the unit performs at the published levels, it is important to determine the indoor airflow and add refrigerant charge accordingly. To charge the system, follow these steps:

1. Measure the indoor airflow.
2. Determine the total system charge.
3. Use the indoor airflow and total system charge results to charge the unit.
4. Charge the indoor TXV in subcooling mode.

Measuring indoor airflow

About this task:

To determine the rated airflow for a specific match, consult the technical literature at <http://www.simplygettingthejobdone.com>. When attempting to match this airflow, select the lowest possible speed tap, measure the actual airflow, and adjust as necessary.

NOTICE

Prevent contamination

Ensure that different refrigerants are not mixed when using charging equipment, and keep hoses or lines as short as possible to minimize refrigerant in them.

Grounding

Ensure that the refrigerating system is properly grounded before charging it with refrigerant

Labeling

Label the system when the charging process is complete, if not already labeled.

Leak testing

After charging but before commissioning, perform a leak test on the system, and conduct a follow-up leak test before leaving the site.

To measure actual airflow, it is not an acceptable method to just check the jumper pin setting tables and to assume 0.5 in. W.C. total external static pressure.

To determine indoor airflow, complete the following steps:

1. Measure the static pressure with a manometer between the filter and blower.
2. **On a single-piece air handler**, take a second reading in the supply air duct outside of the unit. **On a gas furnace**, take the second reading after the heat exchanger but before the indoor coil.

3. Add the negative return static to the positive supply static to determine the system total static pressure. Treat the negative return static as a positive pressure (even though it is a negative reading).
4. If there is static pressure on the blower return (-0.1), add it to a supply static (0.4) which equals a (0.5) total system static pressure.
5. Compare this value to the table for the indoor unit's static pressure against CFM or to a curve chart.

Determining the total system charge

About this task:

The total system charge must be permanently stamped on the unit dataplate. Complete the following steps to determine the total system charge:

1. Determine the base charge shipped in the outdoor unit by referring to the *Tabular Data Sheet* included with the outdoor unit. **(item 1)**
2. Determine the charge adder for the matched indoor unit by referring to the *Tabular Data Sheet*. **(item 2)**
3. If the refrigerant piping is longer than 15 ft (4.6 m), calculate the charge adder for actual piping length by referring to the *Tabular Data Sheet*. **(item 3)**
4. When the charge adders for the matched indoor unit and for the refrigerant piping have been weighed in, verify the system operation against the temperatures and pressures in the charging chart for the outdoor unit. Refer to the charging charts on the outdoor unit or in the *Service Application Data* on <http://www.simplygettingthejobdone.com>. Follow the subcool or the superheat charging procedure in this section according to the type of indoor metering device in the system and allow 10 min after each charge adjustment for the system operation to stabilize. Record the charge adjustment made to match the charging chart. **(item 4)**
5. Verify that the **total system charge = (item 1) + (item 2) + (item 3) = (item 4)**.
6. Permanently stamp the unit data plate with the total system charge as defined in these instructions.
Use this method whenever additional refrigerant is required for the system charge. If a calibrated charging cylinder or accurate weighing device is available, add refrigerant accordingly. Otherwise, model-specific charging charts are provided on the access panel of the unit.

Charging the indoor TXV in subcooling mode

About this task:

The outdoor unit comes equipped with subcooling charts optimized for that particular unit. Follow the instructions on the unit. If those instructions are not readily available, follow the instructions below.

1. Set the system running in cooling mode by setting the thermostat at least 6°F below the room temperature and operate the system for at least 10 min to 15 min.
2. Refer to the *Technical Guide* for the indoor airflow and verify it is correct (it must be between 350 SCFM/ton and 400 SCFM/ton).
3. Measure and record the indoor wet bulb (WB) and the outdoor ambient dry bulb (DB) temperature.
4. Using the charging chart located on the unit, find the intersection of the indoor wet bulb and the outdoor dry bulb. This is the recommended liquid pressure (and subcooling value).
5. Measure and record the pressure at the liquid valve pressure port and compare to the value obtained in Step 4.
6. Add charge if the measured liquid pressure is lower than the recommended value. Remove or recover charge if the measured liquid pressure is above the recommended value.

Example:

The liquid pressure listed at the intersection of the indoor WB and the outdoor DB is 320 psig. The pressure at the liquid valve is 305 psig. It is necessary to add refrigerant to increase the liquid pressure to 320 psig.

ⓘ Note:

Condenser subcooling is obtained by calculating the difference between the saturated refrigerant temperature of the pressure measured at the liquid base valve and the liquid tube temperature as measured at the liquid base valve.

Subcooling Temperature (TC) = Saturated Temperature (TS) – Liquid Temperature (T)

CAUTION

It is unlawful to knowingly vent, release, or discharge refrigerant into the open air during repair, service, maintenance, or the final disposal of this unit.

R-454B saturation properties

Table 10: R-454B saturation properties

Temperature	Liquid pressure	Vapor pressure
°F	psig	psig
35	101	97
40	112	107
45	123	118
50	135	129
55	148	142
60	161	155
65	175	168
70	191	183
75	206	199
80	223	215
85	241	233
90	260	251
95	280	270

Table 10: R-454B saturation properties

Temperature	Liquid pressure	Vapor pressure
°F	psig	psig
100	301	291
105	323	312
110	346	335
115	370	359
120	396	384
125	422	411
130	451	439
135	480	468
140	511	499

Optional cold weather charging

NOTICE

For better airflow, the size of the charging tent must be at least 70 in. x 70 in. x 70 in. and must have some adjustable flaps or windows to control the temperature inside the charging tent. The charging tent must not have a floor or floor covering. Follow the system charge procedures from [Charging the system](#).

About this task:

These optional steps outline how to charge the unit in cold weather using a charging tent.

1. Assemble the charging tent.
2. Slide the charging tent over the top of the outdoor unit.
3. Position the door zipper over the refrigerant piping so the charging tent sits evenly on the ground.
4. Make sure the distance around the outdoor unit inside of the charging tent is even for airflow.
5. Stake down the edges of the charging tent cover to prevent the unit fan from blowing the charging tent away.
6. Start the outdoor unit.
7. For better temperature measurement inside the charging tent, use a thermocouple to monitor temperature readings. Locate the thermocouple monitor approximately 8 in. to 10 in. away from the coil guard and 2/3 of the way above the bottom of the coil on the opposite side from the control box.
8. Based on the outdoor ambient temperature, begin adjusting windows in order to achieve a stable temperature above 55°F inside the tent. Note that the colder the outdoor ambient temperature is the fewer windows need removal.
9. Use the outdoor unit charging chart. Verify that the outdoor ambient temperature listed on the charging chart is the temperature inside the charging tent.
10. Carefully adjust the charging tent windows until reaching the desired temperature, and allow the unit to stabilize for a minimum of 15 min. Check the thermocouple to make sure the temperature is still maintained at the preferred temperature. If the temperature is out of range, adjust the windows by opening or closing them.
11. When the condition inside the charging tent is stabilized, follow the procedures to adjust charge in the unit.

12. Add or remove charge and adjust the windows to maintain the preferred temperature inside the tent.

Starting up the system

Before you begin:

When the outdoor unit is in place and the refrigerant piping and wiring are complete, you must start up the system and make sure that the system is operating correctly.

CAUTION

Do not operate the system until all the checks outlined in this procedure have been performed.

WARNING

Do not touch any of the parts at the discharge gas side by hand. The compressor chamber and the pipes at the discharge side are heated to temperatures higher than 194°F (90°C).

To start up the system, do the following:

1. Check to ensure that the service base valves of the outdoor unit are fully open.
2. Check to ensure that the electric wires are fully connected.
3. Use the thermostat to turn on the system.
4. Make sure that the system is operating correctly.

Instructing the user

When installation and start-up is complete, instruct the owner on the following:

- Processing warranty cards or online registration
- Reviewing the *User's Information Manual*
- Operating and maintaining the unit correctly, how to start, stop, and adjust the temperature setting
- When applicable, instruct the user that the compressor is equipped with a crankcase heater to prevent the migration of refrigerant to the compressor during the **OFF** cycle. The heater is energized only when the unit is not operating in cooling. If the main switch is disconnected for long periods of shut down, do not attempt to start the unit until 8 h after the switch has been connected. This allows sufficient time for all liquid refrigerant to be driven out of the compressor.
- The installer must also instruct the user on correct operation and maintenance of all other system components.

Maintenance and repair

NOTICE

Do not use coil cleaners to clean outdoor coil. Cleaners containing hydrogen fluoride (HF), hydroxides, chlorides, and sulfates can greatly reduce the lifetime of the micro channel coil.

CAUTION

It is unlawful to knowingly vent, release, or discharge refrigerant into the open air during repair, service, maintenance, or the final disposal of this unit.

Repair and maintenance to electrical components must include initial safety checks and component inspection procedures.

Initial safety checks must include:

- Ensure capacitors are discharged to avoid the possibility of sparking.
- Ensure no live electrical components and wiring are exposed while charging, recovering or purging the system.
- Ensure there is continuity of earth bonding.

During repairs to sealed components, all electrical supplies must be disconnected from the equipment being worked upon prior to any removal of sealed covers. If it is absolutely necessary to have an electrical supply to equipment during servicing, then a permanently operating form of leak detection must be located at the most critical point to warn of a potentially hazardous situation.

CAUTION

Be aware that equipment malfunction may be due to refrigerant loss and potential leaks.

It is important to maintain the unit correctly, adhere to the following:

- Do not allow dirt to accumulate on the outdoor coils or other parts in the air circuit. Clean as often as necessary to keep the unit clean. Use a brush, vacuum cleaner attachment, or other suitable means.
- The outdoor fan motor is permanently lubricated and does not require periodic oiling.
- If the coil needs to be cleaned, use clean water to wash dust, dirt, and debris from outdoor coil.
- Refer to the furnace or air handler instructions for filter and blower motor maintenance.
- The indoor coil and drain pan must be inspected and cleaned regularly to prevent odors and assure proper drainage.

Required procedures for A2L systems

The following procedures are required for A2L systems:

Table 11: A2L required procedures

Procedure	A2L
Safely remove refrigerant, following local and national codes.	Required
Purge circuit with inert gas (oxygen-free nitrogen).	Required
Evacuate the refrigerant.	Required
Repair the system and purge with nitrogen during brazing.	Required
Leak test and pressure test the unit.	Required
Evacuate the system.	Required
Charge the system.	Required

Decommissioning

Before you begin:

Before attempting the procedure, complete the following:

- Ensure that the technician is completely familiar with the equipment and all its detail.
- Ensure to safely recover all refrigerants.
- Take an oil and refrigerant sample, in case analysis is required before reusing the recovered refrigerant.
- Ensure that electrical power is available.
- Ensure that mechanical handling equipment is available, if required, for handling refrigerant cylinders.
- Ensure that all personal protective equipment is available and being used correctly.
- Ensure that the recovery process is supervised at all times by a competent person.
- Ensure that recovery equipment and cylinders conform to the appropriate standards.

Follow the steps below to ensure the unit is correctly and safely decommissioned:

1. Isolate the system electrically.
2. Connect a recovery machine to remove refrigerant from the system.
3. Ensure that the cylinder is situated on the scales before recovery takes place.

4. Start the recovery machine and operate in accordance with instructions provided with the machine.

ⓘ Note:

- Do not overfill cylinders to more than 80% volume liquid charge.
- Do not exceed the maximum working pressure of the cylinder, even temporarily.

5. When the cylinders have been filled correctly and the process completed, ensure that the cylinders and the equipment are removed from the site promptly and that all isolation valves on the equipment are closed off.

ⓘ Note: Do not charge recovered refrigerant into another refrigerating system unless it has been cleaned and checked.

What to do next:

Label the equipment stating that it has been decommissioned and emptied of refrigerant. Date and sign the label. For appliances containing flammable refrigerants, ensure that there are labels on the equipment stating that the equipment contains a flammable refrigerant.

Third-party trademarks notice

Third-Party Trademarks Notice: For information about third-party trademarks, refer to the relevant company websites.

Wiring diagrams

Figure 21: Wiring diagram - single-phase 13.4 SEER2 and 14.3 SEER2

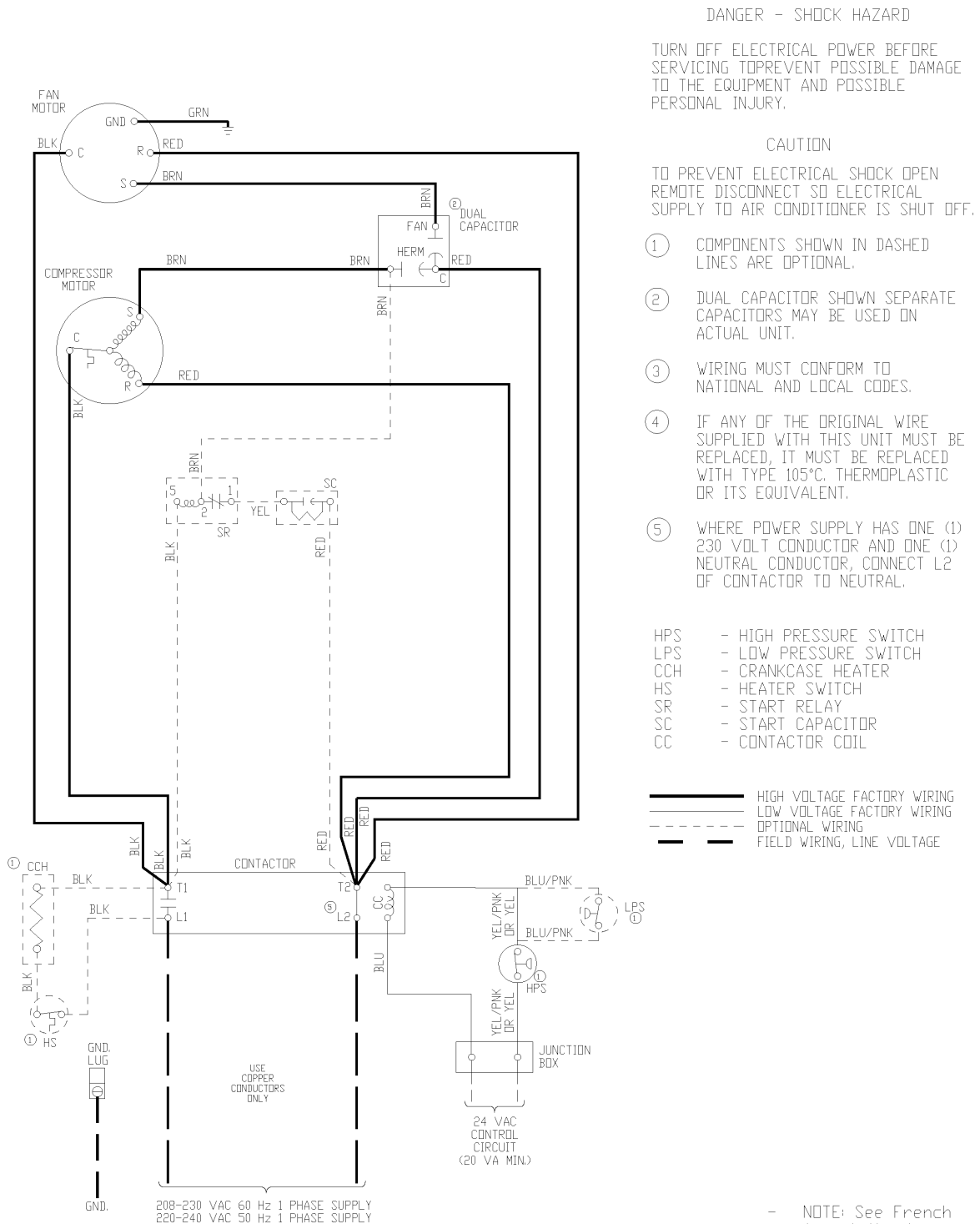

6436388-UWD-A-0021

Figure 22: Wiring diagram - single-stage 16 SEER2

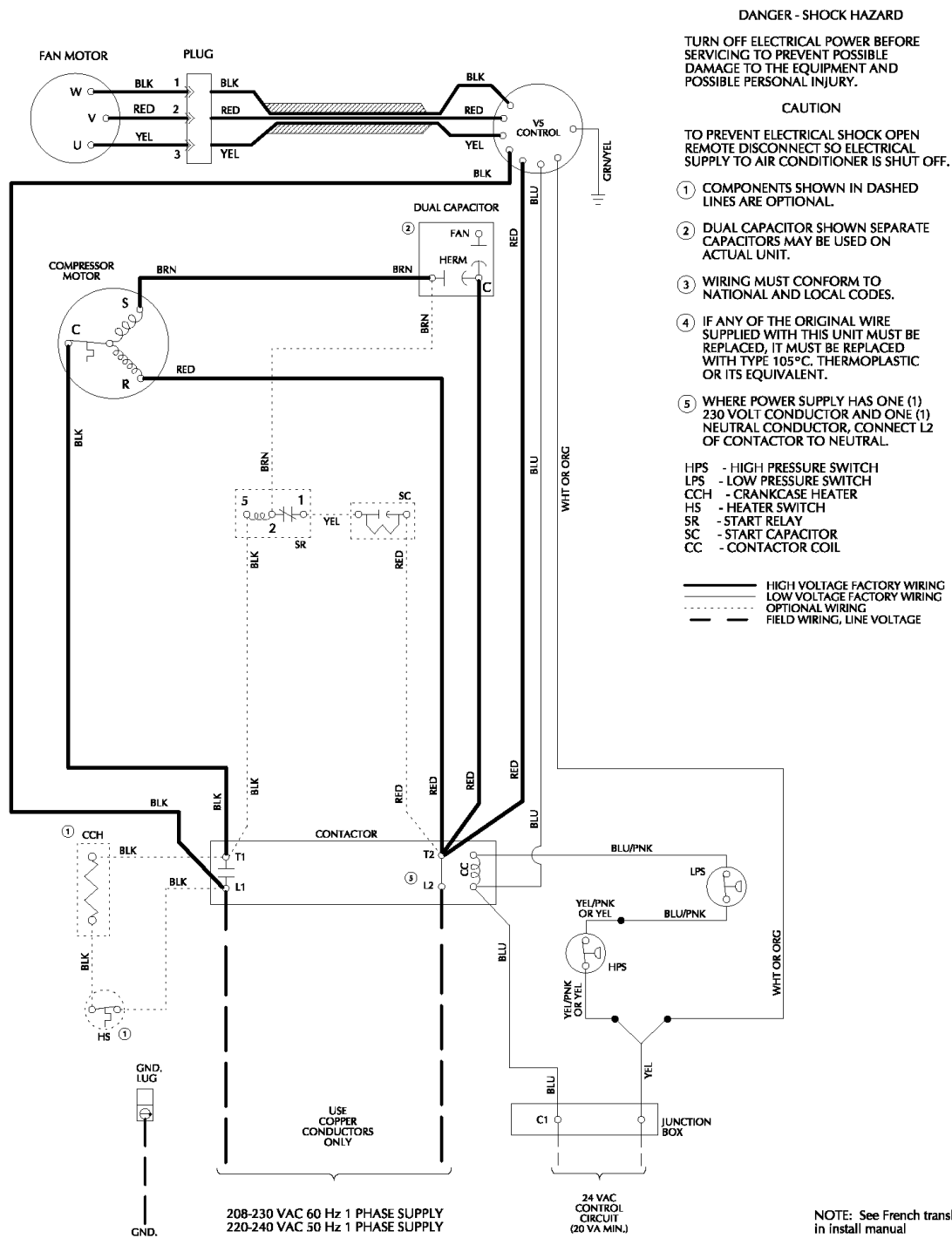

6476430-UWD-A-0224

Figure 23: Wiring diagram - two-stage Copeland compressor 16 SEER2

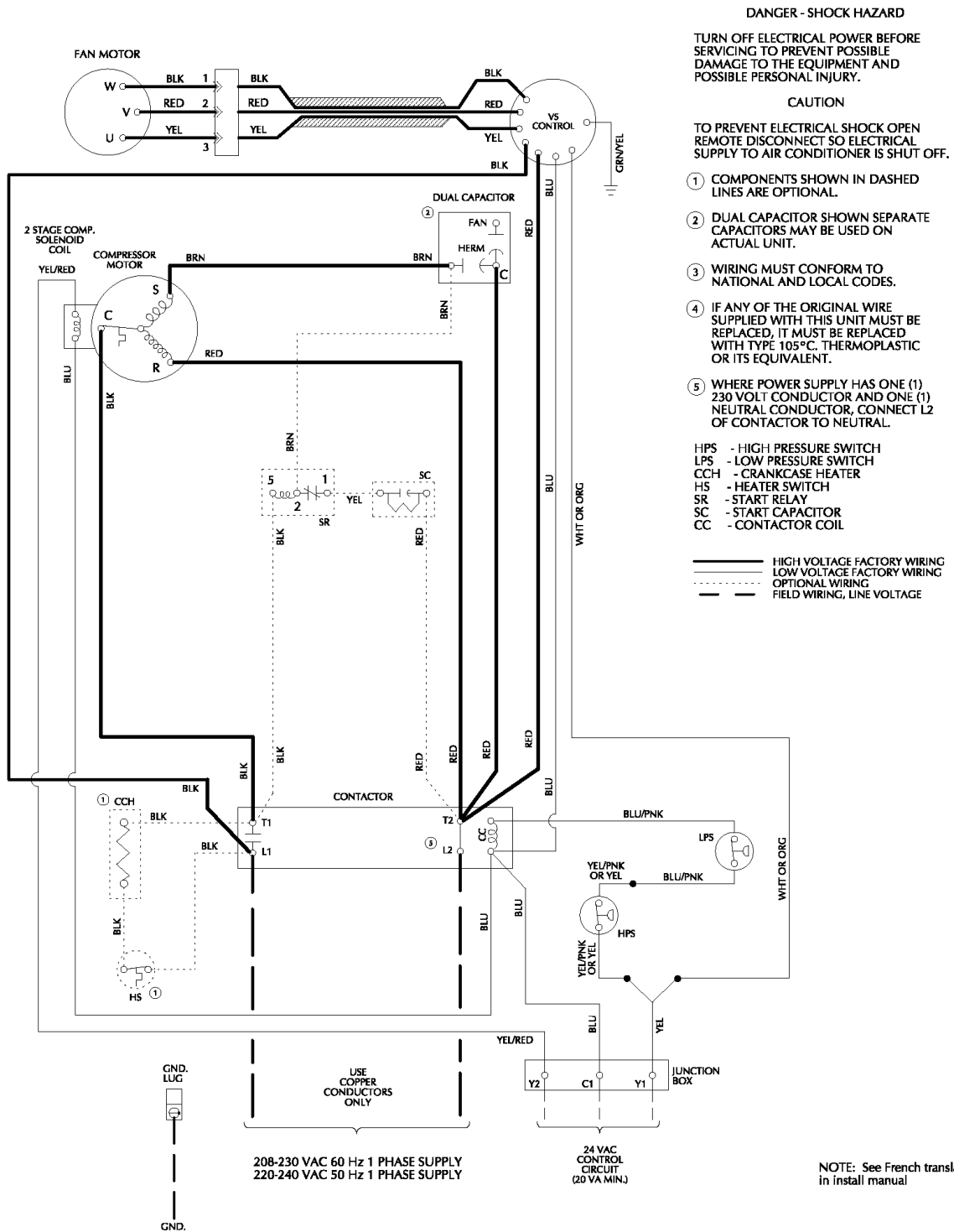

6476431-UWD-A-0224

Figure 24: Wiring diagram - two-stage LG compressor 16 SEER2

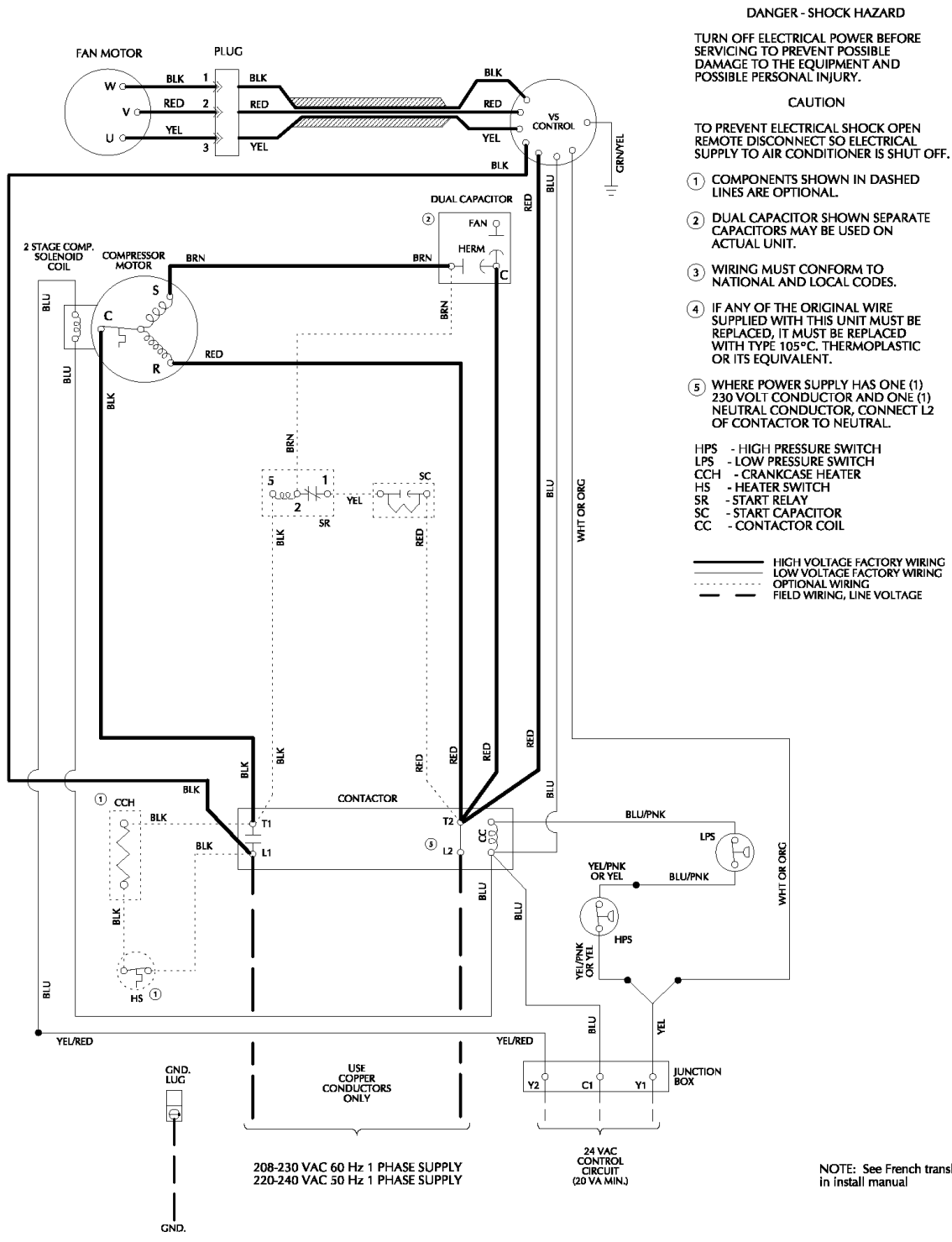

6476432-UWD-A-0224

Figure 25: Wiring diagram - three-phase 13.4 SEER2

DANGER - SHOCK HAZARD

TURN OFF ELECTRICAL POWER BEFORE SERVICING TO PREVENT POSSIBLE DAMAGE TO THE EQUIPMENT AND POSSIBLE PERSONAL INJURY.

CAUTION

TO PREVENT ELECTRICAL SHOCK OPEN REMOTE DISCONNECT SO ELECTRICAL SUPPLY TO AIR CONDITIONER IS SHUT OFF.

- ① COMPONENTS SHOWN IN DASHED LINES ARE OPTIONAL.
- ② BLACK WIRE WILL BE REMOVED IF LOW AMBIENT KIT IS INSTALLED.
- ③ WIRING MUST CONFORM TO NATIONAL AND LOCAL CODES.
- ④ IF ANY OF THE ORIGINAL WIRE SUPPLIED WITH THIS UNIT MUST BE REPLACED, IT MUST BE REPLACED WITH TYPE 105°C, THERMOPLASTIC OR ITS EQUIVALENT.

- HPS - HIGH PRESSURE SWITCH
- LPS - LOW PRESSURE SWITCH
- CCH - CRANKCASE HEATER
- HS - HEATER SWITCH
- CC - CONTACTOR COIL
- FC - FAN CAPACITOR

- HIGH VOLTAGE FACTORY WIRING
- - - LOW VOLTAGE FACTORY WIRING
- · · · · OPTIONAL WIRING
- - - - - FIELD WIRING, LINE VOLTAGE

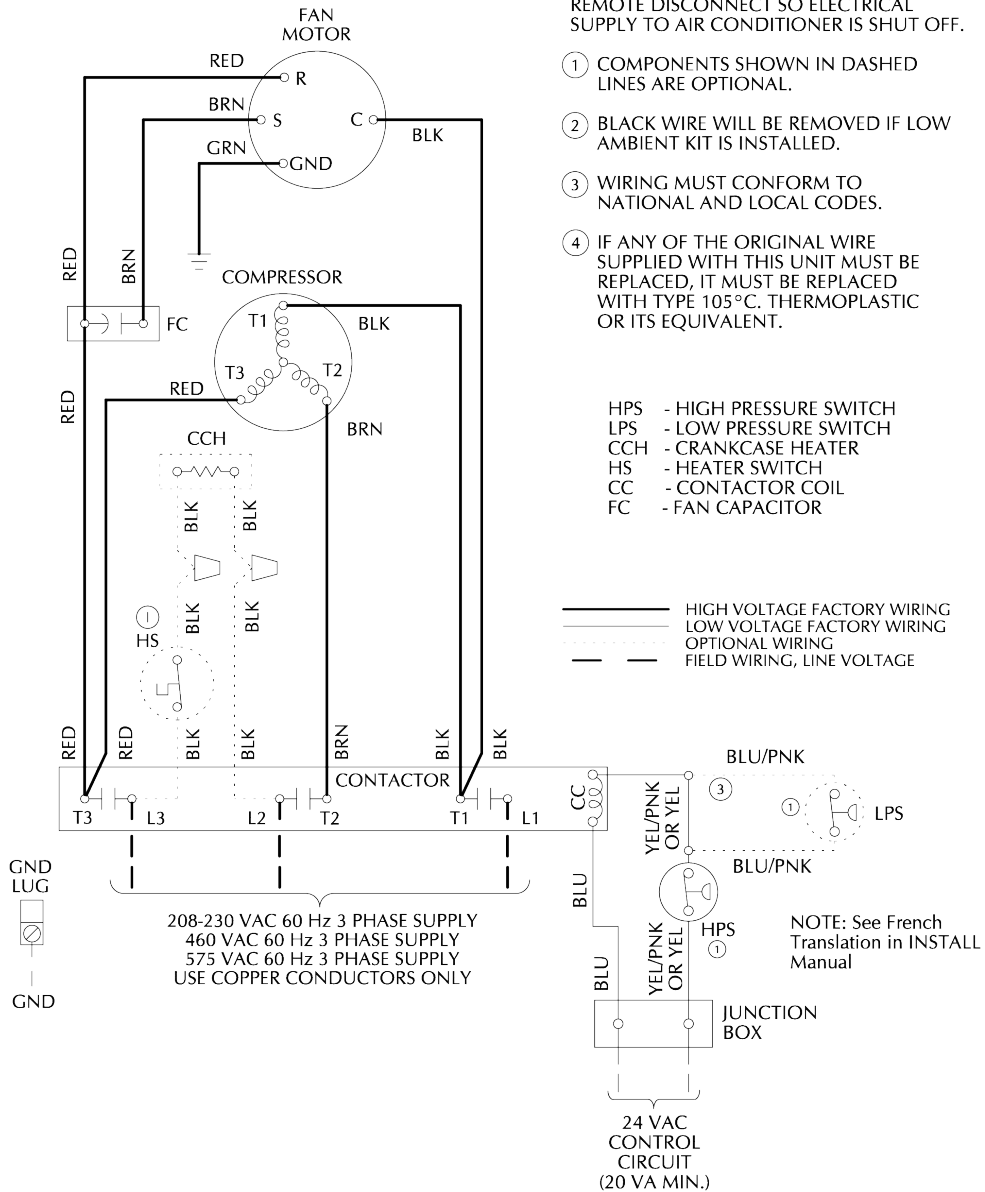

6524777-UWD-A-0624

Start-up sheet

Figure 26: Start-up sheet - page 1

Air Conditioning and Heating Start-Up Sheet
Proper start-up is critical to customer comfort and equipment longevity

Start-Up Date

Technician Performing Start-Up Installing Contractor Name

Owner Information

Name Address

City State or Province Zip or Postal Code

Equipment Data Upflow Downflow Horizontal Left Horizontal Right

Indoor Unit Model # Indoor Unit Serial #

Indoor Coil Model # Indoor Coil Serial #

Outdoor Unit Model # Outdoor Unit Serial #

Filter, Thermostat, Accessories

Filter Type Filter Size Filter Location(s)

Thermostat Type Other System Equipment and Accessories

Connections -- Per Installation Instructions and Local Codes

Unit is level Supply plenum and return ducts are connected and sealed Refrigerant piping complete and leak tested
 Gas piping is connected (if applicable) Vent system is connected (if applicable)
 Condensate drain for indoor coil properly connected Condensate drain for furnace (if applicable)

Electrical: Line Voltage

Indoor unit (volts AC) Outdoor unit (volts AC) Overcurrent Protection Breaker / Fuses Amperes

Ground wire is connected Polarity is correct (120vac indoor units) black is L1 (hot), white is N (neutral)

Electrical: Low Voltage Thermostat wiring complete Heat anticipator recommended value

Heat anticipator is set to the recommended value listed in the Installation Instructions

Low voltage values: "R" and "C" at Indoor unit control board (volts AC) "R" and "C" Outdoor unit control board (volts AC)

Heating Set-Up (if applicable)

Heating Type Electric Air Handler Natural Gas LP Gas (Requires LP Conversion Kit)

Inlet Gas Pressure (in. w.c.) Manifold Gas Pressure (in. w.c.) LP Gas Conversion Kit Part # Used

Calculated input in btuh - clock the gas meter (Nat Gas Only) LP Kit Installed By

Electric Heat Kit Part # (if applicable) KW installed Rated BTU/H (furnaces)

Venting (if applicable) Venting system properly sized, within the limitations of the charts in the installation instructions.

Intake Size # of 90 Degree Ells # of 45 Degree Ells Length

Exhaust Size # of 90 Degree Ells # of 45 Degree Ells Length

Page 1 of 2 (7/5/16)

Figure 27: Start-up sheet - page 2

Airflow Setup											
Blower type and set-up	Variable speed ECM (circle 0 or 1)	Heat	0 / 1	0 / 1							
		Low cool	0 / 1	0 / 1	0 / 1						
		High cool	0 / 1	0 / 1	0 / 1						
		Delay	0 / 1	0 / 1							
		Stage 1 kW	0 / 1	0 / 1							
		Heat kit selection	0 / 1	0 / 1	0 / 1	0 / 1					
	ECM	Compressor high	<input type="radio"/> 1	<input type="radio"/> 2	<input type="radio"/> 3	<input type="radio"/> 4	<input type="radio"/> 5	<input type="radio"/> 6	<input type="radio"/> 7	<input type="radio"/> 8	<input type="radio"/> 9
		Compressor low	<input type="radio"/> 1	<input type="radio"/> 2	<input type="radio"/> 3	<input type="radio"/> 4	<input type="radio"/> 5	<input type="radio"/> 6	<input type="radio"/> 7	<input type="radio"/> 8	<input type="radio"/> 9
		Continuous fan	<input type="radio"/> 1	<input type="radio"/> 2	<input type="radio"/> 3	<input type="radio"/> 4	<input type="radio"/> 5	<input type="radio"/> 6	<input type="radio"/> 7	<input type="radio"/> 8	<input type="radio"/> 9
		Electric heat	<input type="radio"/> 1	<input type="radio"/> 2	<input type="radio"/> 3	<input type="radio"/> 4	<input type="radio"/> 5	<input type="radio"/> 6	<input type="radio"/> 7	<input type="radio"/> 8	<input type="radio"/> 9
Supply static (in. W.C.)	<input style="width: 40px;" type="text"/>	Supply air dry bulb temperature	<input style="width: 40px;" type="text"/>	Outside air dry bulb temperature	<input style="width: 40px;" type="text"/>						
Return static (in. W.C.)	<input style="width: 40px;" type="text"/>	Return air dry bulb temperature	<input style="width: 40px;" type="text"/>	Return air wet bulb temperature	<input style="width: 40px;" type="text"/>						
Total external static pressure	<input style="width: 40px;" type="text"/>	Temperature drop	<input style="width: 40px;" type="text"/>	Supply air wet bulb temperature	<input style="width: 40px;" type="text"/>						
Other switches (check all that apply)											
HUMIDISTAT <input type="radio"/> YES <input type="radio"/> NO AC/HP <input type="radio"/> AC <input type="radio"/> HP CONT FAN <input type="radio"/> 40% <input type="radio"/> 60% <input type="radio"/> 80% <input type="radio"/> 100%											
Refrigerant Charge and Metering Device											
<input type="radio"/> R-454B		<input type="radio"/> TXV <input type="radio"/> Fixed Orifice		Additional Lineset Length <input style="width: 40px;" type="text"/>	Adder per foot - lbs. <input style="width: 40px;" type="text"/> Oz. <input style="width: 40px;" type="text"/>						
# Elbows <input style="width: 40px;" type="text"/>		# 45s <input style="width: 40px;" type="text"/>		Total Added - lbs. <input style="width: 40px;" type="text"/> Oz. <input style="width: 40px;" type="text"/>							
Orifice Size <input style="width: 40px;" type="text"/>	Liquid Line Temp <input style="width: 40px;" type="text"/>	High Side Pressure <input style="width: 40px;" type="text"/>	Suction Line Temp <input style="width: 40px;" type="text"/>	Low Side Pressure <input style="width: 40px;" type="text"/>							
TXV # <input style="width: 40px;" type="text"/>	Subcooling <input style="width: 40px;" type="text"/>			Superheat <input style="width: 40px;" type="text"/>							
Cycle Test											
<input type="checkbox"/> Operate the unit through continuous fan cycles from the thermostat, noting and correcting any problems											
<input type="checkbox"/> Operate the unit through a cooling cycles, noting and correcting any problems											
<input type="checkbox"/> Operate the unit through several heating cycles (if applicable) from the thermostat, noting and correcting any problems											
Clean Up											
<input type="checkbox"/> Installation debris disposed of and indoor and outdoor areas cleaned up?											
Owner Education											
<input type="checkbox"/> Provide owner with the owner's manual											
<input type="checkbox"/> Explain operation of system to equipment owner											
<input type="checkbox"/> Explain thermostat use and programming (if applicable) to owner											
<input type="checkbox"/> Explain the importance of regular filter replacement and equipment maintenance											
Comments Section											