

Service Manual

"P" SERIES 9K - 12K 220V INVERTER-DRIVEN AIR CONDITIONING UNITS

Type	Model
INDOOR UNIT	DHP09NWB21S DCP09NWB21S DHP12NWB21S DCP12NWB21S

Type	Model
OUTDOOR UNIT	DHP09CSB21S DCP09CSB21S DHP12CSB21S DCP12CSB21S

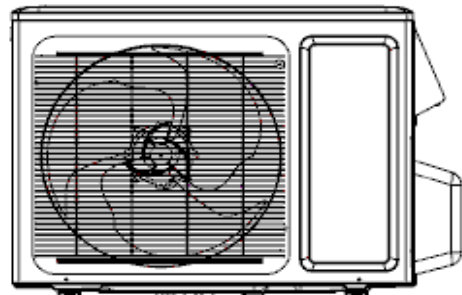

—A DCF H5 BH.

PLEASE READ AND UNDERSTAND THIS MANUAL BEFORE USING THIS INVERTER-DRIVEN AIR CONDITIONING UNIT. KEEP THIS MANUAL FOR FUTURE REFERENCE.

Important Notice

- Johnson Controls, Inc. pursues a policy of continuing improvement in design and performance in its products. As such, Johnson Controls, Inc. reserves the right to make changes at any time without prior notice.
- Johnson Controls, Inc. cannot anticipate every possible circumstance that might involve a potential hazard.
- This inverter air conditioning unit is designed for standard air conditioning applications only. Do not use this unit for anything other than the purposes for which it was intended for.
- The installer and system specialist should safeguard against leakage in accordance with local pipefitter and electrical codes. The following standards may be applicable, if local regulations are not available. International Organization for Standardization: (ISO 5149 or European Standard, EN 378). No part of this manual may be reproduced in any way without the expressed written consent of Johnson Controls, Inc.
- This inverter-driven (cooling or heat pump) air conditioning unit will be operated and serviced in the United States of America and comes with all required Safety, Danger, and Caution, warnings.
- If you have questions, please contact your distributor or dealer.
- This manual provides common descriptions, basic and advanced information to maintain and service this inverter-driven (cooling or heat pump) air conditioning unit which you operate, as well for other models.
- This inverter-driven (cooling or heat pump) air conditioning unit has been designed for a specific temperature range. For optimum performance and long life, operate this unit within range limits.
- This manual should be considered as a permanent part of the air conditioning equipment and should remain with the air conditioning equipment.

Product Inspection upon Arrival

1. Upon receiving this product, inspect it for any damages incurred in transit. Claims for damage, either apparent or concealed, should be filed immediately with the shipping company.
2. Check the model number, electrical characteristics (power supply, voltage, and frequency rating), and any accessories to determine if they agree with the purchase order.
3. The standard utilization for this unit is explained in these instructions. Use of this equipment for purposes other than what it designed for is not recommended.
4. Please contact your local agent or contractor as any issues involving installation, performance, or maintenance arise. Liability does not cover defects originating from unauthorized modifications performed by a customer without the written consent of Johnson Controls, Inc. Performing any mechanical alterations on this product without the consent of the manufacturer will render your warranty null and void.

Table of Contents

Safety Summary	i
1. Technical Information and Summary	1
2. Specifications	2
2.1 Specification Sheet.....	2
2.2 Operation Characteristic Curve.....	6
2.3 Capacity Variation Ratio According to Temperature.....	6
2.4 Cooling and Heating Data Sheet in Rated Frequency.....	7
2.5 Noise Curve.....	7
3. Outline Dimension Diagram	8
3.1 Indoor Unit.....	8
3.2 Outdoor Unit.....	9
4. Refrigerant System Diagram	10
5. Electrical Parts	11
5.1 Wiring Diagram.....	11
5.2 PCB Printed Diagram.....	13
6. Function and Control	15
6.1 Remote Controller Introduction.....	15
6.2 Brief Description of Modes and Functions.....	19
7. Maintenance	28
7.1 Precautions before Maintenance.....	28
7.2 Error Code List.....	29
7.3 Troubleshooting for Main Malfunction.....	30
7.4 Troubleshooting for Normal Malfunction.....	43
8. Removal Procedures	45
8.1 Removal Procedures Indoor Unit.....	45
8.2 Removal Procedures Outdoor Unit.....	50
Appendix:	55
Appendix 1: Reference Sheet of Celsius and Fahrenheit.....	55
Appendix 2: Configuration of Connection Pipe.....	55
Appendix 3: Pipe Flaring Method.....	56
Appendix 4: List of Resistance for Temperature Sensor.....	57
Customer Service, Technical Support	60





1. Introduction

This manual concentrates on inverter-driven cooling or heat pump air conditioning units. Read this manual carefully before installation.

This manual should be considered as a permanent part of the air conditioning equipment and should remain with the air conditioning equipment.

2. Important Safety Instructions

Safety Messages

	Indicates a hazardous situation that, if not avoided, could result in death or serious injury.
	Indicates a hazardous situation that, if not avoided, could result in minor or moderate injury.
	Indicates information considered important, but not hazard-related (for example, messages relating to property damage).
General Precautions	
	To reduce the risk of serious injury or death, read these instructions thoroughly and follow all warnings or cautions included in all manuals that accompanied the product and are attached to the unit. <i>Refer back to these safety instructions as needed.</i>

- This system should be installed by personnel certified by Johnson Controls, Inc. Personnel must be qualified according to local, state and national building and safety codes and regulations. Incorrect installation could cause leaks, electric shock, fire or explosion. In areas where Seismic Performance requirements are specified, the appropriate measures should be taken during installation to guard against possible damage or injury that might occur in an earthquake if the unit is not installed correctly, injuries may occur due to a falling unit.
- Use appropriate Personal Protective Equipment (PPE), such as gloves and protective goggles and, where appropriate, have a gas mask nearby. Also use electrical protection equipment and tools suited for electrical operation purposes. Keep a quenching cloth and a fire extinguisher nearby during brazing. Use care in handling, rigging, and setting of bulky equipment.
- When transporting, be careful when picking up, moving and mounting these units. Although the unit may be packed using plastic straps, do not use them for transporting the unit from one location to another. Do not stand on or put any material on the unit. Get a partner to help, and bend with your knees when lifting to reduce strain on your back. Sharp edges or thin aluminum fins on the air conditioner can cut fingers, so wear protective gloves.
- Do not touch or adjust any safety devices inside the indoor or outdoor units. All safety features, disengagement, and interlocks must be in place and functioning correctly before the equipment is put into operation. If these devices are improperly adjusted or tampered with in any way, a serious accident can occur. Never bypass or jump-out any safety device or switch.
- Johnson Controls, Inc. will not assume any liability for injuries or damage caused by not following steps outlined or described in this manual. Unauthorized modifications to Johnson Controls products are prohibited as they...
 - May create hazards which could result in death, serious injury or equipment damage.
 - Will void product warranties.
 - May invalidate product regulatory certifications.
 - May violate OSHA standards.

NOTICE

Take the following precautions to reduce the risk of property damage.

- Be careful that moisture, dust, or variant refrigerant compounds not enter the refrigerant cycle during installation work. Foreign matter could damage internal components or cause blockages.
- If air filters are required on this unit, do not operate the unit without the air filter set in place. If the air filter is not installed, dust may accumulate and breakdown may result.
- Do not install this unit in any place where silicon gases can coalesce. If the silicon gas molecules attach themselves to the surface of the heat exchanger, the finned surfaces will repel water. As a result, any amount of condensate can overflow from the condensate pan and could run inside of the electrical box, possibly causing electrical failures.
- When installing the unit in a hospital or other facility where electromagnetic waves are generated from nearby medical and/or electronic devices, be prepared for noise and electronic interference Electromagnetic Interference (EMI). Do not install where the waves can directly radiate into the electrical box, controller cable, or controller. Inverters, appliances, high-frequency medical equipment, and radio communications equipment may cause the unit to malfunction. The operation of the unit may also adversely affect these same devices. Install the unit at least 10 ft. (approximately 3m) away from such devices.
- When a wireless zone controller is used, locate at a distance of at least 3.3 ft. (approximately 1 meter) between the indoor unit and electric lighting. If not, the receiver part of the unit may have difficulty receiving operation commands.
- Do not install the unit in any location where animals and plants can come into direct contact with the outlet air stream. Exposure could adversely affect the animals and plants.
- Do not install the unit with any downward slope to the side of the drain boss. If you do, you may have water flowing back which may cause leaks.
- Be sure the condensate hose discharges water properly. If connected incorrectly, it may cause leaks.
- Do not install the unit in any place where oil can seep onto the units, such as table or seating areas in restaurants, and so forth. For these locations or social venues, use specialized units with oil-resistant features built into them. In addition, use a specialized ceiling fan designed for restaurant use. These specialized oil-resistant units can be ordered for such applications. However, in places where large quantities of oil can splash onto the unit, such as a factory, even the specialized units cannot be used. These products should not be installed in such locations.

Installation Precautions

WARNING

To reduce the risk of serious injury or death, the following installation precautions must be followed.

- When installing the unit into...
 - A wall: Make sure the wall is strong enough to hold the unit's weight. It may be necessary to construct a strong wood or metal frame to provide added support.
 - A room: Properly insulate any refrigerant tubing run inside a room to prevent "sweating" that can cause dripping and water damage to wall and floors.
 - Damp or uneven areas: Use a raised concrete pad or concrete blocks to provide a solid, level foundation for the unit to prevent water damage and abnormal vibration.
 - An area with high winds: Securely anchor the outdoor unit down with bolts and a metal frame. Provide a suitable air baffle.
 - A snowy area (only for heat pump model): Install the outdoor unit on a raised platform that is higher than drifting snow. Provide snow vents.
- Do not install the unit in the following places. Doing so can result in an explosion, fire, deformation, corrosion, or product failure.
 - Explosive or flammable atmosphere
 - Where fire, oil, steam, or powder can directly enter the unit, such as in close proximity or directly above a kitchen stove.
 - Where oil (including machinery oil) may be present.
 - Where corrosive gases such as chlorine, bromine, or sulfide can accumulate, such as near a hot tub or hot spring.
 - Where dense, salt-laden airflow is heavy, such as in coastal regions.
 - Where the air quality is of high acidity.
 - Where harmful gases can be generated from decomposition.

- Do not position the condensate pipe for the indoor unit near any sanitary sewers where corrosive gases may be present. If you do, toxic gases can seep into breathable air spaces and can cause respiratory injuries. If the condensate pipe is installed incorrectly, water leakage and damage to the ceiling, floor, furniture, or other possessions may result. If condensate piping becomes clogged, moisture can back up and can drip from the indoor unit. Do not install the indoor unit where such dripping can cause moisture damage or uneven locations: Use a raised concrete pad or concrete blocks to provide a solid, level foundation for the unit to prevent water damage and abnormal vibration.
- Before performing any brazing work, be sure that there are no flammable materials or open flames nearby.
- Perform a run test to ensure normal operation. Safety guards, shields, barriers, covers, and protective devices must be in place while the compressor/unit is operating. During the test run, keep fingers and clothing away from any moving parts.
- Clean up the site when finished, remembering to check that no metal scraps or bits of wiring have been left inside the unit being installed.
- During transportation, do not allow the backrest of the forklift to make contact with the unit, otherwise, it may cause damage to the heat exchanger and also may cause injury when stopped or started suddenly.
- Remove gas inside the closing pipe when the brazing work is performed. If the brazing filler metal is melted with remaining gas inside, the pipes will be blown off and it may cause injury.
- Be sure to use nitrogen gas for an airtight test. If other gases such as oxygen gas, acetylene gas or fluorocarbon gas are accidentally used, it may cause explosion or gas intoxication.

After installation work for the system has been completed, explain the “Safety Precautions,” the proper use and maintenance of the unit to the customer according to the information in all manuals that came with the system. All manuals and warranty information must be given to the user or left near the Indoor Unit.

Refrigerant Precautions



To reduce the risk of serious injury or death, the following refrigerant precautions must be followed.

- As originally manufactured, this unit contains refrigerant installed by Johnson Controls. Johnson Controls uses only refrigerants that have been approved for use in the unit’s intended home country or market. Johnson Controls distributors similarly are only authorized to provide refrigerants that have been approved for use in the countries or markets they serve. The refrigerant used in this unit is identified on the unit’s faceplate and/or in the associated manuals. Any additions of refrigerant into this unit must comply with the country’s requirements with regard to refrigerant use and should be obtained from Johnson Controls distributors. Use of any non-approved refrigerant substitutes will void the warranty and will increase the potential risk of injury or death.
- If installed in a small room, take measures to prevent the refrigerant from exceeding the maximum allowable concentration in the event that refrigerant gases should escape. Refrigerant gases can cause asphyxiation (0.42 kg/m³ based on ISO 5149 for R410A). Consult with your distributor for countermeasures (ventilation system and so on). If refrigerant gas has leaked during the installation work, ventilate the room immediately.
- The design pressure for this product is 601 psi (4.15MPa). The pressure of R410A refrigerant is 1.4 times higher than that of the refrigerant R22. Therefore, the refrigerant piping for R410A should be thicker than that for R22. Make sure to use the specified refrigerant piping. If not, the refrigerant piping may rupture due to an excessive refrigerant pressure. Besides, pay attention to the piping thickness when using copper refrigerant piping. The thickness of copper refrigerant piping differs depending on its material.
- The refrigerant R410A is adopted. The refrigerant oil tends to be affected by foreign matters such as moisture, oxide film, (or fat). Perform the installation work with care to prevent moisture, dust, or different refrigerant from entering the refrigerant cycle. Foreign matter can be introduced into the cycle from such parts as expansion valve and the operation may be unavailable.
- To avoid the possibility of different refrigerant or refrigerant oil being introduced into the cycle, the sizes of the charging connections have been changed from R407C type and R22 type. It is necessary to prepare the appropriate tools before performing the installation work.
- Use refrigerant pipes and joints which are approved for use with R410A.
- A compressor/unit comprises a pressurized system. Never loosen threaded joints while the system is

under pressure and never open pressurized system parts.

- Before installation is complete, make sure that the refrigerant leak test has been performed. If refrigerant gases escape into the air, turn OFF the main switch, extinguish any open flames and contact your service contractor. Refrigerant (Fluorocarbon) for this unit is odorless. If the refrigerant should leak and come into contact with open flames, toxic gas could be generated. Also, because the fluorocarbons are heavier than air, they settle to the floor, which could cause asphyxiation.
- When installing the unit, and connecting refrigerant piping, keep all piping runs as short as possible, and make sure to securely connect the refrigerant piping before the compressor starts operating. If the refrigerant piping is not connected and the compressor activates with the stop valve opened, the refrigerant cycle will become subjected to extremely high pressure, which can cause an explosion or fire.
- Tighten the flare nut with a torque wrench in the specified manner. Do not apply excessive force to the flare nut when tightening. If you do, the flare nut can crack and refrigerant leakage may occur.
- When maintaining, relocating, and disposing of the unit, dismantle the refrigerant piping after the compressor stops.
- When pipes are removed out from under the piping cover, after the insulation work is completed, cover the gap between the piping cover and pipes by a packing (field-supplied). If the gap is not covered, the unit may be damaged if snow, rain water or small animals enter the unit.
- Do not apply an excessive force to the spindle valve at the end of opening. Otherwise, the spindle valve flies out due to refrigerant pressure. At the run test, fully open the gas and liquid valves, otherwise, these devices will be damaged. (It is closed before shipment.)
- If the arrangement for outdoor units is incorrect, it may cause flowback of the refrigerant and result in failure of the outdoor unit.
- The refrigerant system may be damaged if the slope of the piping connection kit exceeds $\pm 15^\circ$.

Electrical Precautions



Take the following precautions to reduce the risk of electric shock, fire or explosion resulting in serious injury or death.

- Highly dangerous electrical voltages are used in this system. Carefully refer to the wiring diagram and these instructions when wiring. Improper connections and inadequate grounding can cause serious injury or death.
- Perform all electrical work in strict accordance with this installation and maintenance manual and all the relevant regulatory standards.
- Before servicing, open and tag all disconnect switches. Never assume electrical power is disconnected. Check with meter and equipment.
- Only use electrical protection equipment and tools suited for this installation.
- Use specified cables between units.
- The new air conditioner may not function normally in the following instances:
 - If electrical power for the new air conditioner is supplied from the same transformer as the device* referred to below.
 - If the power source cables for this device* and the new air conditioner unit are located in close proximity to each other.

Device*: (Example): A lift, container crane, rectifier for electric railway, inverter power device, arc furnace, electric furnace, large-sized induction motor and large-sized switch.

Regarding the cases mentioned above, surge voltage may be inducted into the power supply cables for the packaged air conditioner due to a rapid change in power consumption of the device and an activation of a switch.

Check field regulations and standards before performing electrical work in order to protect the power supply for the new air conditioner unit.

- Communication cabling shall be a minimum of 18-Gauge, 2-Conductor, Stranded Copper. Shielded cable must be considered for applications and routing in areas of high EMI and other sources of potentially excessive electrical noise to reduce the potential for communication errors. When shielded cabling is applied, proper bonding and termination of the cable shield is required as per Johnson Controls guidelines. Plenum and riser ratings for communication cables must be considered per application and local code requirements.
- Use an exclusive power supply for the air conditioner at the unit's rated voltage.
- Be sure to install circuit breakers (ground fault interrupter, isolating switch, molded case circuit breaker and so on), with the specified capacity. Ensure that the wiring terminals are tightened securely to recommended torque specifications.
- Clamp electrical wires securely with a cable clamp after all wiring is connected to the terminal block. In addition, run wires securely through the wiring access channel.
- When installing the power lines, do not apply tension to the cables. Secure the suspended cables at regular intervals, but not too tightly.
- Make sure that the terminals do not come into contact with the surface of the electrical box. If the terminals are too close to the surface, it may lead to failures at the terminal connection.
- Turn OFF and disconnect the unit from the power source when handling the service connector. Do not open the service cover or access panel to the indoor or outdoor units without turning OFF the main power supply.
- After ceasing operation, be sure to wait at least five minutes before turning off the main power switch. Otherwise, water leakage or electrical breakdown may result. Disconnect the power source completely before attempting any maintenance for electrical parts. Check to ensure that no residual voltage is present after disconnecting the power source.
- Do not clean with, or pour water into, the controller as it could cause electric shock and/or damage the unit. Do not use strong detergent such as a solvent. Clean with a soft cloth.
- Check that the ground wire is securely connected. Do not connect ground wiring to gas piping, water piping, lighting conductor, or telephone ground wiring.
- If a circuit breaker or fuse is frequently activated, shut down the system and contact your service contractor.
- Perform all electrical work in accordance with this manual and in compliance with all regulations and safety standards.
- Do not open a service access cover or panel of an indoor or outdoor unit without first turning OFF the power at the main power supply.
- Residual voltage can cause electric shock. At all times, check for residual voltage after disconnecting from the power source before starting work on the unit.
- This equipment can be installed with a Ground Fault Circuit Breaker (GFCI), which is a recognized measure for added protection to a properly grounded unit. Install appropriate sized breakers/fuses/overcurrent protection switches, and wiring in accordance with local, state and NEC codes and requirements. The equipment installer is responsible for understanding and abiding by applicable codes and requirements.

2. Specifications

2.1 Specification Sheet

Model			DHP09NWB21S DHP09CSB21S	DCP09NWB21S DCP09CSB21S	
Power Supply	Rated Voltage	V~	208/230	208/230	
	Rated Frequency	Hz	60	60	
	Phases		1	1	
Power Supply Mode			Outdoor	Outdoor	
Cooling Capacity(Min~Max)		Btu/h	9000(3100~9600)	9000(3100~9600)	
Heating Capacity(Min~Max)		Btu/h	/	9500(3100~12000)	
Cooling Power Input(Min~Max)		W	900(375~1300)	900(375~1300)	
Heating Power Input(Min~Max)		W	/	800(300~1350)	
Cooling Power Current		A	4	4	
Heating Power Current		A	/	3.6	
Rated Input		W	1300	1350	
Rated Current		A	5.8	6.0	
Air Flow Volume(SH/H/M/L)		CFM	318/288/241/171	318/288/241/171	
Dehumidifying Volume		Pint/h	1.69	1.69	
EER		(Btu/h)/W	10.00	10.00	
COP		(Btu/h)/W	/	11.88	
SEER			16.00	16.00	
HSPF			/	9.00	
Application Area		yd ²	14.35-21.53	14.35-21.53	
Indoor Unit	Model of indoor unit		DHP09NWB21S	DCP09NWB21S	
	Fan Type		Cross-flow	Cross-flow	
	Diameter Length(DXL)		inch	Φ3 7/8X22 13/16	Φ3 7/8X22 13/16
	Fan Motor Cooling Speed(SH/H/M/L)		r/min	1350/1200/1050/750/-	1350/1200/1050/750/-
	Fan Motor Heating Speed(SH/H/M/L)		r/min	/	1350/1200/1050/850/-
	Output of Fan Motor		W	20	20
	Fan Motor RLA		A	0.215	0.215
	Fan Motor Capacitor		μF	1	1
	Evaporator Form			Aluminum Fin-copper Tube	Aluminum Fin-copper Tube
	Pipe Diameter		inch	Φ3/16	Φ3/16
	Row-fin Gap		inch	2-1/16	2-1/16
	Coil Length (LXD _X W)		inch	23X7/8X10 1/2	23X7/8X10 1/2
	Swing Motor Model			MP24AA	MP24AA
	Output of Swing Motor		W	1.5	1.5
	Fuse		A	3.15	3.15
	Sound Pressure Level(SH/H/M/L)		dB (A)	43/38/34/28/-	43/38/34/28/-
	Sound Power Level(SH/H/M/L)		dB (A)	53/48/44/38/-	53/48/44/38/-
	Dimension (WXHXD)		inch	31 1/8X10 7/8X7 7/8	31 1/8X10 7/8X7 7/8
	Dimension of Carton Box (LXWXH)		inch	34X10 9/16X13 7/8	34X10 9/16X13 7/8
	Dimension of Package (LXWXH)		inch	34X10 11/16X14 7/16	34X10 11/16X14 7/16
Net Weight		lb	19.8	19.8	
Gross Weight		lb	24.3	24.3	

	Model of Outdoor Unit		DHP09CSB21S	DCP09CSB21S
	Compressor Manufacturer/Trademark		ZHUHAI GREE DAIKIN DEVICE CO.,LTD	ZHUHAI GREE DAIKIN DEVICE CO.,LTD
	Compressor Model		1GDY23AXD	1GDY23AXD
	Compressor Oil		DAPHNE FVC50K	DAPHNE FVC50K
	Compressor Type		Swing	Swing
	Compressor Locked Rotor Amp (L.R.A)	A	/	/
	Compressor RLA	A	4.00	4.00
	Compressor Power Input	W	845	845
	Overload Protector		KSD115°C or HPC115/95	KSD115°C or HPC115/95
	Metering Device		Capillary	Capillary
	Operation temp	°F	60.8~86	60.8~86
	Ambient temp (cooling)	°F	0~115	0~115
	Ambient temp (heating)	°F	/	-4~75
	Condenser Form		Aluminum Fin-copper Tube	Aluminum Fin-copper Tube
	Pipe Diameter	inch	Φ5/16	Φ5/16
	Rows-fin Gap	inch	1-1/16	1-1/16
	Coil Length (LXD _X W)	inch	28X3/4X20	28X3/4X20
	Fan Motor Speed	rpm	820	820
	Output of Fan Motor	W	30	30
	Fan Motor RLA	A	0.36	0.36
	Fan Motor Capacitor	μF	/	/
	Air Flow Volume of Outdoor Unit	CFM	942	942
	Fan Type		Axial-flow	Axial-flow
	Fan Diameter	inch	Φ15 3/4	Φ15 3/4
	Defrosting Method		/	Automatic Defrosting
	Climate Type Cannot cool when temp is above 109°F		T1	T1
	Isolation		I	I
	Moisture Protection		IP24	IP24
	Permissible Excessive Operating Pressure for the Discharge Side	PSIG	620	620
	Permissible Excessive Operating Pressure for the Suction Side	PSIG	360	360
	Sound Pressure Level (H/M/L)	dB (A)	52/-/-	52/-/-
	Sound Power Level (H/M/L)	dB (A)	62/-/-	62/-/-
	Dimension (WXHXD)	inch	30 9/16X21 1/4X12 5/8	30 9/16X21 1/4X12 5/8
	Dimension of Carton Box (LXWXH)	inch	33 3/8X14 3/16X22 13/16	33 3/8X14 3/16X22 13/16
	Dimension of Package (LXWXH)	inch	33 1/2X14 5/16X23 7/16	33 1/2X14 5/16X23 7/16
	Net Weight	lb	66.2	65.0
	Gross Weight	lb	71.7	70.6
	Refrigerant		R410A	R410A
	Refrigerant Charge	oz	24.7	24.7
Outdoor Unit	Length	ft	24.6	24.6
	Gas Additional Charge	oz/ft	0.2	0.2
	Outer Diameter Liquid Pipe	inch	Φ1/4	Φ1/4
	Outer Diameter Gas Pipe	inch	Φ3/8	Φ3/8
	Max Distance Height	ft	32.8	32.8
	Max Distance Length	ft	49.2	49.2
Note:The connection pipe applies metric diameter.				

The above data is subject to change without notice. Please refer to the nameplate of the unit.

Model			DCP12NWB21S DCP12CSB21S	DHP12NWB21S DHP12CSB21S
Power Supply		Rated Voltage	V~	208/230
		Rated Frequency	Hz	60
		Phases		1
Power Supply Mode			Outdoor	Outdoor
Cooling Capacity(Min~Max)		Btu/h	12000(3753~12500)	12000(3753~12500)
Heating Capacity(Min~Max)		Btu/h	/	13000(3924~14000)
Cooling Power Input(Min~Max)		W	1300(410~1350)	1300(410~1350)
Heating Power Input(Min~Max)		W	/	1250(380~1500)
Cooling Power Current		A	5.8	5.8
Heating Power Current		A	/	5.6
Rated Input		W	1350	1500
Rated Current		A	5.8	6.7
Air Flow Volume(SH/H/M/L)		CFM	400/318/253/194	400/318/253/194
Dehumidifying Volume		Pint/h	2.96	2.96
EER		(Btu/h)/W	9.23	9.23
COP		(Btu/h)/W	/	10.40
SEER			16.00	16.00
HSPF			/	9.00
Application Area		yd ²	19.14-28.70	19.14-28.70
Indoor Unit	Model of indoor unit		DCP12NWB21S	DHP12NWB21S
			7.CB419N07100	6.CB438N01400
	Fan Type		Cross-flow	Cross-flow
	Diameter Length(DXL)		inch	Φ3 7/8X25
	Fan Motor Cooling Speed(SH/H/M/L)		r/min	1350/1200/1000/800/-
	Fan Motor Heating Speed(SH/H/M/L)		r/min	/
	Output of Fan Motor		W	20
	Fan Motor RLA		A	0.21
	Fan Motor Capacitor		μF	1.5
	Evaporator Form			Aluminum Fin-copper Tube
	Pipe Diameter		inch	Φ3/16
	Row-fin Gap		inch	2-1/16
	Coil Length (LXDXW)		inch	25X7/8X12 1/16
	Swing Motor Model			MP24BA
	Output of Swing Motor		W	1.5
	Fuse		A	3.15
	Sound Pressure Level(SH/H/M/L)		dB (A)	45/39/35/29/-
	Sound Power Level(SH/H/M/L)		dB (A)	55/49/45/39/-
	Dimension (WXHXD)		inch	33 1/4X11 3/8X8 1/4
	Dimension of Carton Box (LXWXH)		inch	36 1/8X11X14 5/16
Dimension of Package (LXWXH)		inch	36 1/4X11X15	
Net Weight		lb	23.2	
Gross Weight		lb	27.6	

Outdoor Unit	Model of Outdoor Unit		DCP12CSB21S	DHP12CSB21S
	Compressor Manufacturer/Trademark		ZHUHAI GREE DAIKIN DEVICE CO.,LTD	ZHUHAI GREE DAIKIN DEVICE CO.,LTD
	Compressor Model		1GDY23AXD	1GDY23AXD
	Compressor Oil		DAPHNE FVC50K	DAPHNE FVC50K
	Compressor Type		Swing	Swing
	Compressor Locked Rotor Amp (L.R.A)	A	/	/
	Compressor RLA	A	4.00	4.00
	Compressor Power Input	W	845	845
	Overload Protector		KSD115°C or HPC115/95	KSD115°C or HPC115/95
	Metering Device		Capillary	Capillary
	Operation temp	°F	60.8~86	60.8~86
	Ambient temp (cooling)	°F	0~115	0~115
	Ambient temp (heating)	°F	/	-4~75
	Condenser Form		Aluminum Fin-copper Tube	Aluminum Fin-copper Tube
	Pipe Diameter	inch	Φ5/16	Φ5/16
	Rows-fin Gap	inch	2-1/16	2-1/16
	Coil Length (LXDXW)	inch	28X1 1/2X20	28X1 1/2X20
	Fan Motor Speed	rpm	820	820
	Output of Fan Motor	W	30	30
	Fan Motor RLA	A	0.36	0.36
	Fan Motor Capacitor	μF	/	/
	Air Flow Volume of Outdoor Unit	CFM	942	942
	Fan Type		Axial-flow	Axial-flow
	Fan Diameter	inch	Φ15 3/4	Φ15 3/4
	Defrosting Method		/	Automatic Defrosting
	Climate Type Cannot cool when temp is above 109°F		T1	T1
	Isolation		I	I
	Moisture Protection		IP24	IP24
	Permissible Excessive Operating Pressure for the Discharge Side	PSIG	620	620
	Permissible Excessive Operating Pressure for the Suction Side	PSIG	360	360
	Sound Pressure Level (H/M/L)	dB (A)	52/-/-	53/-/-
	Sound Power Level (H/M/L)	dB (A)	62/-/-	63/-/-
	Dimension (WXHXD)	inch	30 9/16X21 1/4X12 5/8	30 9/16X21 1/4X12 5/8
Dimension of Carton Box (LXWXH)	inch	33 3/8X14 3/16X22 13/16	33 3/8X14 3/16X22 13/16	
Dimension of Package (LXWXH)	inch	33 1/2X14 5/16X23 7/16	33 1/2X14 5/16X23 7/16	
Net Weight	lb	69.5	70.6	
Gross Weight	lb	75	76.1	
Refrigerant		R410A	R410A	
Refrigerant Charge	oz	30.0	30.0	
Connection Pipe	Length	ft	24.6	24.6
	Gas Additional Charge	oz/ft	0.2	0.2
	Outer Diameter Liquid Pipe	inch	Φ1/4	Φ1/4
	Outer Diameter Gas Pipe	inch	Φ3/8	Φ3/8
	Max Distance Height	ft	32.8	32.8
	Max Distance Length	ft	49.2	49.2
	Note:The connection pipe applies metric diameter.			

The above data is subject to change without notice. Please refer to the nameplate of the unit.

2.2 Operation Characteristic Curve

Cooling

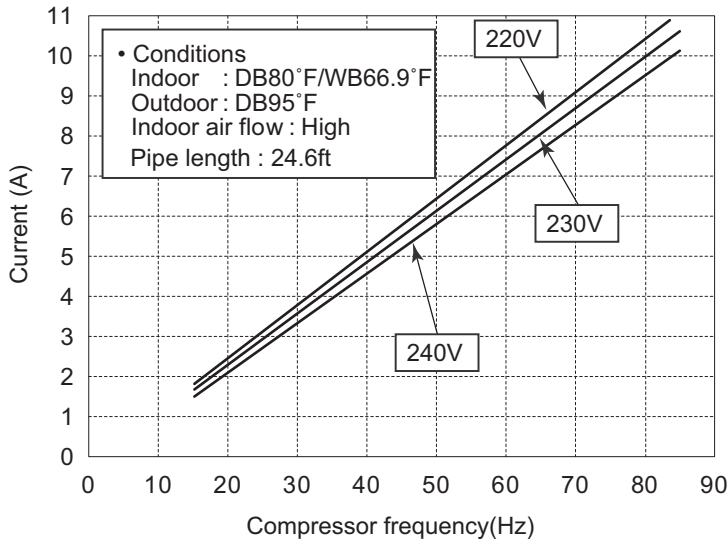

Heating

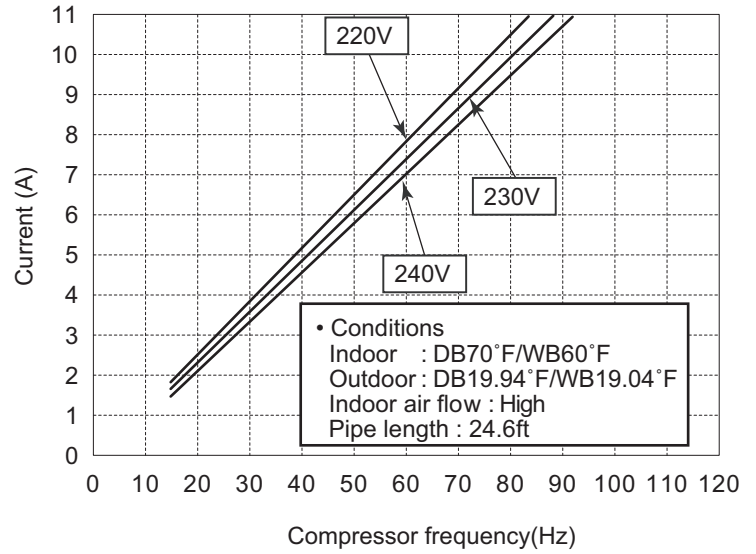

2.3 Capacity Variation Ratio According to Temperature

Cooling

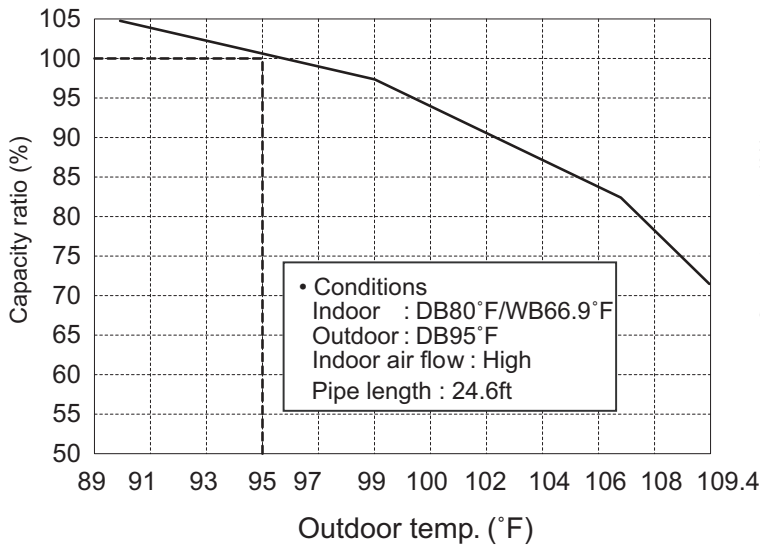

Heating

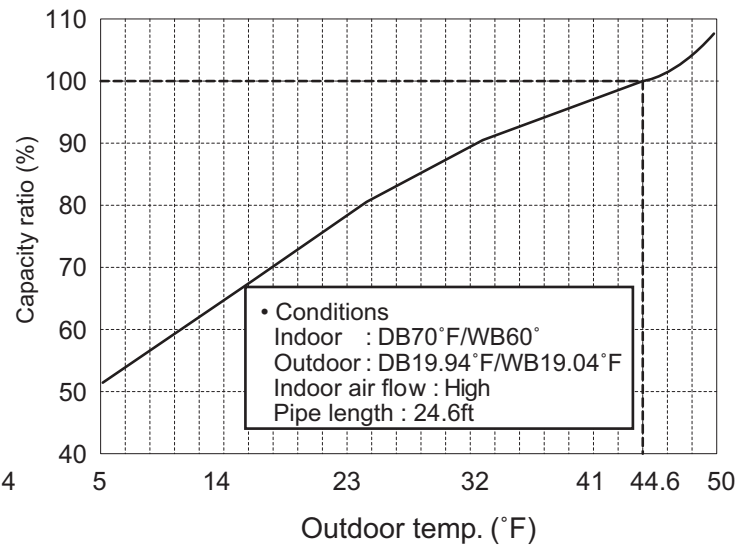

2.4 Cooling and Heating Data Sheet in Rated Frequency

Cooling:

Rated cooling condition(°F) (DB/WB)		Model	Pressure of gas pipe connecting indoor and outdoor unit	Inlet and outlet pipe temperature of heat exchanger		Fan speed of indoor unit	Fan speed of outdoor unit	Compressor revolution RPS x 3 = HZ
Indoor	Outdoor			T1 (°F)	T2 (°F)			
80/66.9	95/-	09K	130~142	in:46.4~51.8 out:51.8~57.2	in:167~181.4 out:98.6~118.4	Super High	High	52
80/66.9	95/-	12K	130~142	in:46.4~51.8 out:51.8~57.2	in:167~181.4 out:98.6~118.4	Super High	High	72

Heating:

Rated heating condition(°F) (DB/WB)		Model	Pressure of gas pipe connecting indoor and outdoor unit	Inlet and outlet pipe temperature of heat exchanger		Fan speed of indoor unit	Fan speed of outdoor unit	Compressor revolution RPS x 3 = HZ
Indoor	Outdoor			T1 (°F)	T2 (°F)			
70/60	19.94/19.04	09K	362~406	in:167~181.4 out:98.6~113	in:33.8~37.4 out:35.6~42.8	Super High	High	65
70/60	19.94/19.04	12K	362~406	in:167~181.4 out:98.6~113	in:33.8~37.4 out:35.6~42.8	Super High	High	77

Instruction:

T1: Inlet and outlet pipe temperature of evaporator
 T2: Inlet and outlet pipe temperature of condenser
 P: Pressure at the side of king valve
 Connection pipe length: 24.6ft.

2.5 Noise Curve

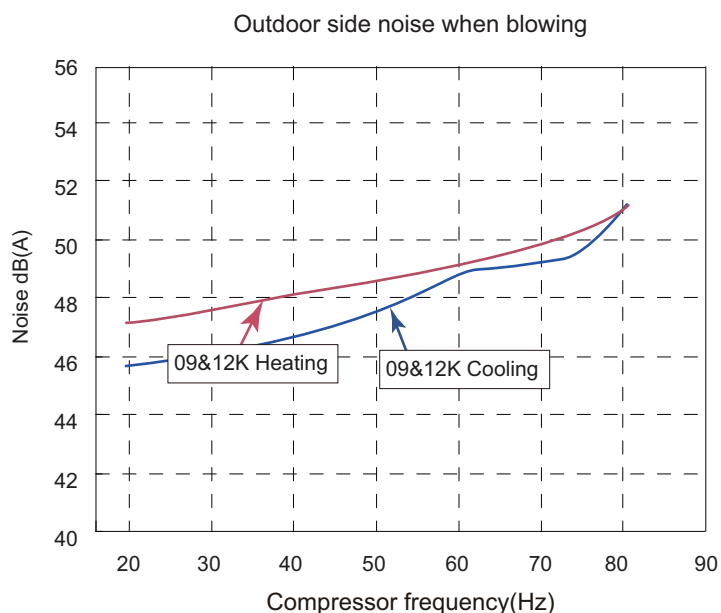
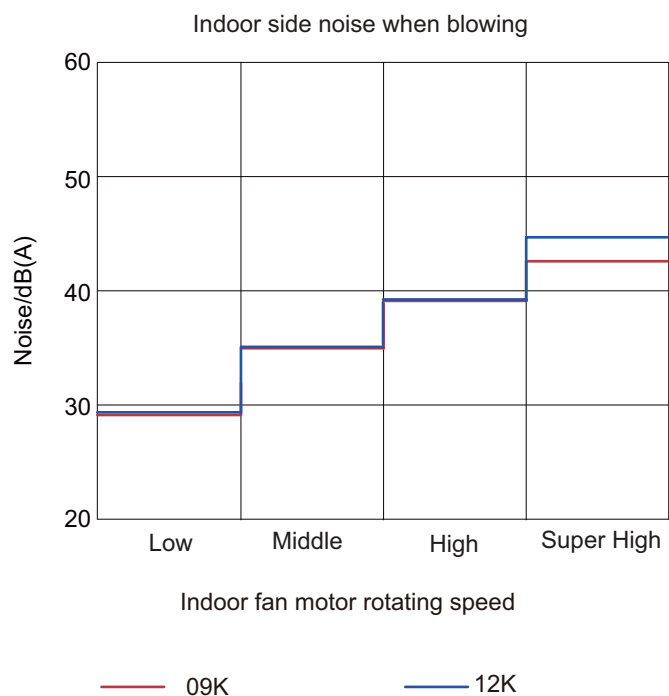

3.2 Outdoor Unit

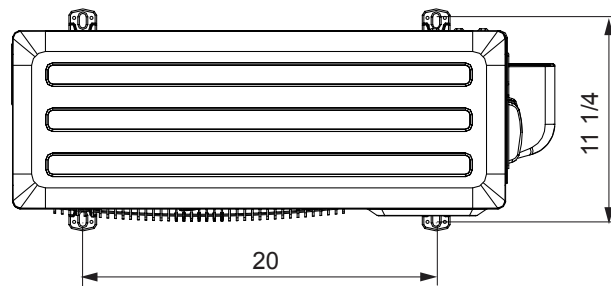
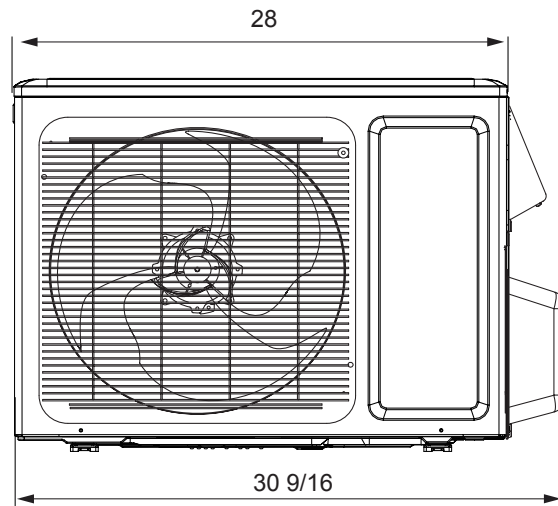
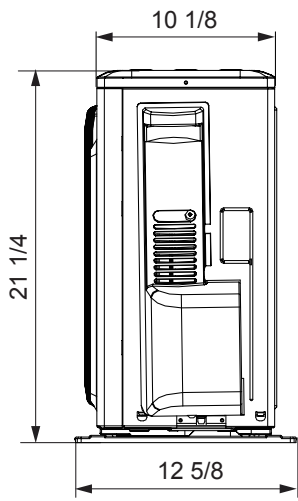

6. Function and Control

6.1 Remote Controller Introduction



- 1 ON/OFF button
- 2 MODE button
- 3 FAN button
- 4 SWING button
- 5 TURBO button
- 6 ▲/ ▼button
- 7 SLEEP button
- 8 TEMP button
- 9 I FEEL button
- 10 LIGHT button
- 11 CLOCK button
- 12 TIMER ON / TIMER OFF button

Introduction for icons on display screen

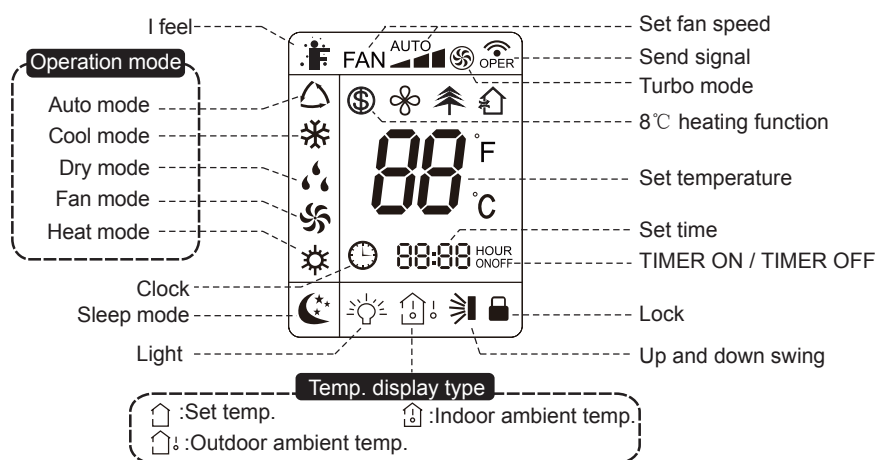

Introduction for buttons on remote controller

Note:

- After putting through the power, the air conditioner will give out a sound. Operation indicator "🔌" is ON (red indicator). After that, you can operate the air conditioner using the controller.
- Under ON status, pressing the button on the remote controller, the signal icon "📶" on the display of remote controller will blink once and the air conditioner will give out a beep sound, which means the signal has been sent to the air conditioner.
- Under OFF status, set temperature and clock icon will be displayed on the display of controller (If timer ON, timer OFF and light functions are set, the corresponding icons will be displayed on the display of controller at the same time). Under ON status, the display will show the corresponding set function icons.

1. ON/OFF button

Pressing this button can turn on or turn off the air conditioner. After turning on the air conditioner, operation indicator "⏻" on indoor unit's display is ON (green indicator). The color is different for different models, and the indoor unit will give out a sound.

2. MODE button

Press this button to select your required operation mode.

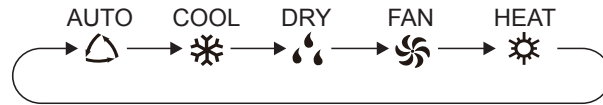

- When selecting auto mode, air conditioner will operate automatically according to factory setting. Set temperature can't be adjusted and will not be displayed as well. Press "FAN" button can adjust fan speed. Pressing "SWING" button can adjust fan blowing angle.
- After selecting cool mode, air conditioner will operate under cool mode. Cool indicator "❄️" on indoor unit is ON. Press "▲" or "▼" button to adjust set temperature. Press "FAN" button to adjust fan speed. Press "SWING" button to adjust fan blowing angle.
- When selecting dry mode, the air conditioner operates at low speed under dry mode. Dry indicator "💧" on indoor unit is ON. Under dry mode, fan speed can't be adjusted. Press "SWING" button to adjust fan blowing angle.
- When selecting fan mode, only the indoor fan will be on to circulate the indoor air. No cooling and no heating. All indicators are OFF. Press "FAN" button to adjust fan speed. Press "SWING" button to adjust fan blowing angle.
- When selecting heating mode, the air conditioner operates under heat mode. Heat indicator "☀️" on indoor unit is ON. Press "▲" or "▼" button to adjust set temperature. Press "FAN" button to adjust fan speed. Press "SWING" button to adjust fan blowing angle. (Cooling only unit won't receive heating mode signal. If setting heat mode with remote controller, press ON/OFF button can't start up the unit).

Note:

- For preventing cold air, after starting up heating mode, indoor fan will delay until the indoor coil reaches preset factory temperature that is controlled by the inlet pipe sensor. Normal preset temperature is 92°F.
- Set temperature range from remote controller: 60.8~86°F (16~30°C). Fan speed: auto, low speed, medium speed, high speed.

3. FAN button

Pressing this button can set fan speed circularly as: auto (AUTO), low(🏠), medium(🏠🏠), high(🏠🏠🏠).



Caution:

- Under AUTO speed, air conditioner will select proper fan speed automatically according to factory setting.
- Fan speed under dry mode is low speed.

4. SWING button

Pressing this button can select up and down swing angle. Fan blowing angle can be selected as below:

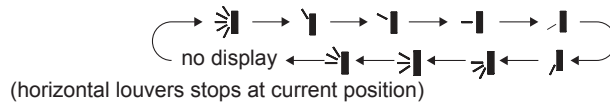

- When selecting "🌀", air conditioner is blowing fan automatically. Horizontal louver will automatically swing up and down at maximum angle.
- When selecting "🏠", "🏠", "🏠", "🏠", "🏠", air conditioner is blowing fan at fixed position. Horizontal louver will stop at the fixed position.
- When selecting "🏠", "🏠", "🏠", air conditioner is blowing fan at fixed angle. Horizontal louver will send air at the fixed angle.
- Hold "🏠" button above 2s to set your required swing angle. When reaching your required angle, release the button.

Note:

- "🏠", "🏠", "🏠" may not be available. When the air conditioner receives this signal, the air conditioner will blow fan automatically.

5. TURBO button

Under COOL or HEAT mode, press this button to turn to quick COOL or quick HEAT mode. "⚡" icon is displayed on remote controller. Press this button again to exit turbo function and "⚡" icon will disappear.

6. ▲/▼ button

- Press "▲" or "▼" button once increase or decrease set temperature 1°C(1°F). Holding "▲" or "▼" button, 2s later, set temperature on remote controller will change quickly. On releasing button after setting is finished, temperature indicator on indoor unit will change accordingly. (Temperature can't be adjusted under auto mode)

- When setting TIMER ON, TIMER OFF or CLOCK, press "▲" or "▲" button to adjust time. (Refer to CLOCK, TIMER ON, TIMER OFF buttons.) When setting TIMER ON, TIMER OFF or CLOCK, press "▲" or "▲" button to adjust time. (Refer to CLOCK, TIMER ON, TIMER OFF buttons.)

7. SLEEP button

Under COOL, HEAT or DRY mode, press this button to start up sleep function. "☾" icon is displayed on remote controller. Press this button again to cancel sleep function and "☾" icon will disappear.

8. TEMP button

By pressing this button, you can see indoor set temperature, indoor ambient temperature or outdoor ambient temperature on indoor unit's display. The setting on remote controller is selected circularly as below:

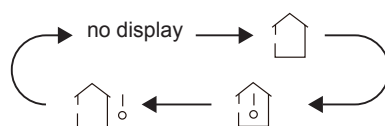

- When selecting "🏠" or no display with remote controller, temperature indicator on indoor unit displays set temperature.
- When selecting "🏠🌡️" with remote controller, temperature indicator on indoor unit displays indoor ambient temperature.
- When selecting "🏠🌡️!" with remote controller, temperature indicator on indoor unit displays outdoor ambient temperature.

Note:

- Outdoor temperature display is not available for some models. At that time, indoor unit receives "🏠🌡️!" signal, while it displays indoor set temperature.
- It's defaulted to display set temperature when turning on the unit. There is no display in the remote controller.
- **Only for the models paired with an indoor unit is there a dual-8 display.**
- When selecting display of indoor or outdoor ambient temperature, indoor temperature indicator displays corresponding temperature and automatically turns to display set temperature after three to five seconds.

9. I FEEL button

Press this button to start I FEEL function and "🌡️" will be displayed on the remote controller. After this function is set, the remote controller will send the detected ambient temperature to the controller and the unit will automatically adjust the indoor temperature according to the detected temperature. Press this button again to close I FEEL function and "🌡️" will disappear.

- Please put the remote controller near user when this function is set. Do not put the remote controller near an object of high temperature or low temperature in order to avoid detecting inaccurate ambient temperature.

10. LIGHT button

Press this button to turn off display light on indoor unit. "💡" icon on remote controller disappears. Press this button again to turn on display light. "💡" icon is displayed.

11. CLOCK button

Press this button to set clock time. "🕒" icon on remote controller will blink. Press "▲" or "▼" button within 5s to set clock time. Each pressing of "▲" or "▼" button, clock time will increase or decrease 1 minute. If hold "▲" or "▼" button, 2s later, time will change quickly. Release this button when reaching your required time. Press "CLOCK" button to confirm the time. "🕒" icon stops blinking.

Note:

- Clock time adopts 24-hour mode.
- The interval between two operations can't exceed 5s. Otherwise, remote controller will quit setting status. Operation for TIMER ON/TIMER OFF is the same.

12. TIMER ON / TIMER OFF button

• TIMER ON button

"TIMER ON" button can set the time for timer on. After pressing this button, "🕒" icon disappears and the word "ON" on remote controller blinks. Press "▲" or "▼" button to adjust TIMER ON setting. After each pressing "▲" or "▼" button, TIMER ON setting will increase or decrease 1min. Hold "▲" or "▼" button, 2s later, the time will change quickly until reaching your required time. Press "TIMER ON" to confirm it. The word "ON" will stop blinking. "🕒" icon resumes displaying. Cancel TIMER ON: Under the condition that TIMER ON is started up, press "TIMER ON" button to cancel it.

• TIMER OFF button

"TIMER OFF" button can set the time for timer off. After pressing this button, "🕒" icon disappears and the word "OFF" on remote controller blinks. Press "▲" or "▼" button to adjust TIMER OFF setting. After each pressing "▲" or "▼" button, TIMER OFF setting will increase or decrease 1min. Hold "▲" or "▼" button, 2s later, the time will change quickly until reaching your required time. Press "TIMER OFF" word "OFF" will stop blinking. "🕒" icon resumes displaying. Cancel TIMER OFF. Under the condition that TIMER OFF is started up, press "TIMER OFF" button to cancel it.

Note:

- Under On and Off status, you can set TIMER OFF or TIMER ON simultaneously.
- Before setting TIMER ON or TIMER OFF, please adjust the clock time.
- After starting up TIMER ON or TIMER OFF, the air conditioner will be turned on or turned off according to setting time. ON/OFF button has no effect on setting. If you don't need this function, please use remote controller to cancel it.

Function introduction for combination buttons

1. Energy-saving function

Under cooling mode, press "TEMP" and "CLOCK" buttons simultaneously to start up or turn off energy-saving function. When energy-saving function is started up, "SE" will be shown on remote controller, and air conditioner will adjust the set temperature automatically according to factory setting to reach to the best energy-saving effect. Press "TEMP" and "CLOCK" buttons simultaneously again to exit energy-saving function.

Note:

- Under energy-saving function, fan speed is defaulted at auto speed and it can't be adjusted.
- Under energy-saving function, set temperature can't be adjusted. Press "TURBO" button and the remote controller won't send signal.
- Sleep function and energy-saving function can't operate at the same time. If energy-saving function has been set under cooling mode, pressing sleep button will cancel energy-saving function. If sleep function has been set under cooling mode, starting up the energy-saving function will cancel the sleep function.



2. 46.4°F (8°C) heating function

Under heating mode, press "TEMP" and "CLOCK" buttons simultaneously to start up or turn off 8°C heating function. When this function is started up, "8°C" and "8°C" will be shown on remote controller, and the air conditioner keeps the heating status at 8°C. Press "TEMP" and "CLOCK" buttons simultaneously again to exit 8°C heating function.

Note:

- Under 8°C heating function, fan speed is defaulted at auto speed and it can't be adjusted.
- Under 8°C heating function, set temperature can't be adjusted. Press "TURBO" button and the remote controller won't send signal.
- Sleep function and 8°C heating function can't operate at the same time. If 8°C heating function has been set under cooling mode, pressing sleep button will cancel 8°C heating function. If sleep function has been set under cooling mode, starting up the 8°C heating function will cancel sleep function.
- Under °F temperature display, the remote controller will display 46 °F heating.

3. Lock function

Press "▲" or "▲" simultaneously to turn on or turn off the lock function. When lock function is on,  icon is displayed on remote controller. If you operate the remote controller, the  icon will blink three times without sending a signal to the unit.

4. Temperature display switch-over function

Under OFF status, press "▼" and "MODE" buttons simultaneously to switch temperature display between °C and °F .

Operation guide

1. After putting through the power, press "ON/OFF" button on remote controller to turn on the air conditioner.
2. Press "MODE" button to select your required mode: AUTO, COOL, DRY, FAN, HEAT.
3. Press "▲" or "▼" button to set your required temperature. (Temperature can't be adjusted under auto mode).
4. Press "FAN" button to set your required fan speed: auto, low, medium and high speed.
5. Press "SWING" button to select fan blowing angle.

Replacement of batteries in remote controller

1. Press the back side of remote controller marked with "  ", as shown in the figure, and then push out the cover of battery box along the arrow direction.
2. Replace two 7# (AAA 1.5V) dry batteries, and make sure the position of "+" polar and "-" polar are correct.
3. Reinstall the cover of battery box.

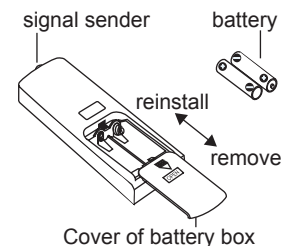

Note:

- During operation, point the remote control signal sender at the receiving window on indoor unit.
- **The distance between signal sender and receiving window should be no more than 24.3ft (8m), and there should be no obstacles between them.**
- Signal may be interfered with in a room where there is fluorescent light or wireless telephone; remote controller should be close to indoor unit during operation.
- Replace new batteries of the same model when replacement is required.
- When you don't use remote controller for a long period of time, please take out the batteries.
- If the display on remote controller is fuzzy or there's no display, please replace batteries.

6.2 Brief Description of Modes and Functions

● Indoor Unit

1. Basic function of system

(1) Cooling mode

- (1) Under this mode, fan and swing operate at setting status.
- (2) During malfunction of outdoor unit or the unit is stopped because of protection, indoor unit keeps original operation status.

(2) Drying mode

- (1) Under this mode, fan operates at low speed and swing operates at setting status.
- (2) During malfunction of outdoor unit or the unit is stopped because of protection, indoor unit keeps original operation status.
- (3) Protection status is same as that under cooling mode.
- (4) Sleep function is not available for drying mode.

(3) Heating mode

- (1) Under this mode, Temperature setting on the remote setpoint is 60.8~86.0°F.
- (2) Working condition and process for heating mode:

When turning on the unit under heating mode, the indoor unit's fan motor will stop until the preheating of the indoor coil above 86°F to prevent cool/cold air start-up in heat mode.

1. (4) Working method for AUTO mode:

Working condition and process for AUTO mode:

a. Under AUTO mode, standard heating T_{preset}=68.0°F and standard cooling T_{preset}=77.0°F. The unit will switch from heat to cool automatically within the preset factory settings.

2. Protection function

- a. During cooling operation, protection function is same as that under cooling mode.
 - b. During heating operation, protection function is same as that under heating mode.
3. Display: Set temperature is the set value under each condition.
 4. If there's I feel function, T_{compensation} is 0. Others are as above.

(5) Fan mode

Fan mode will only run the indoor fan motor to circulate the indoor air, with no outdoor unit function under fan mode. The indoor fan can operate at high, medium, low or auto fan speed.

2. Other control

(1) Buzzer

When power is applied to the unit and/or when the remote buttons are pressed, the buzzer will give out a beep.

(2) Auto button

If pressing this auto button when turning off the unit, press the auto button again to turn off auto mode.

(3) Auto fan

Heating mode: During auto heating mode or normal heating mode, auto fan speed will adjust the fan speed automatically according to ambient temperature and set temperature.

(4) Sleep

After setting sleep function for a period of time, system will adjust set temperature automatically.

(5) Timer function:

General timer and clock timer functions are compatible by equipping remote controller with different functions.

(6) Memory function

Memorizes compensation temperature, off-peak energization value.

Memory content: Mode, up and down swing, light, set temperature, set fan speed, general timer (clock timer can't be memorized).

After power recovery, the unit will turn on automatically according to memory content.

(7) Health function

During operation of indoor fan, set health function by remote controller. Turning off the unit will also turn off health function.

Turn on the unit by pressing auto button, and the health is defaulted ON.

(8) I feel control mode

After controller received I feel control signal and ambient temperature sent by remote controller, controller will work according to the ambient temperature sent by remote controller.

(9) Compulsory defrosting function

(1) Start up compulsory defrosting function

Under ON status, set heating mode with remote controller and adjust the temperature to 60.8°F. Press “+, -, +, -, +,-” button successively within 5s and the complete unit will enter into compulsory defrosting status. Meanwhile, heating indicator on indoor unit will ON 10s and OFF 0.5s successively. (Note: If complete unit has malfunction or stops operation due to protection, compulsory defrosting function can be started up after malfunction or protection is resumed.)

(2) Exit compulsory defrosting mode

After compulsory defrosting is started up, the complete unit will exit defrosting operation according to the actual defrosting result, and the complete unit will resume normal heating operation.

(10) Refrigerant recovery function:

(1) Enter refrigerant recycling function

Within 5min after energizing (unit ON or OFF status is ok), repeatedly press the LIGHT button three times within 3s to enter refrigerant recycling mode. Fo is displayed and refrigerant recycling function is started. At this moment, close the liquid valve. After 5min, use an Allen wrench tool to close/open the king valve. If there is no refrigerant spraying out, close the gas valve immediately and then use off the unit to remove the connection pipe.

(2) Exit refrigerant recycling function

After entering refrigerant recycling mode, when receiving any remote control signal or entering refrigerant recycling mode for 25min, the unit will exit refrigerant recycling mode automatically. If the unit is in standby mode before refrigerant recycling, it will still be in standby mode after finishing refrigerant recycling; if the unit is in ON status before refrigerant recycling, it will still run in original operation mode.

(11) Ambient temperature display control mode

1. When user sets the remote controller to display set temperature (corresponding remote control code: 01), current set temperature will be displayed.

2. Only when remote control signal is switched to indoor ambient temperature display status (corresponding remote control code: 10) from other display status (corresponding remote control code: 00, 01,11), controller will display indoor ambient temperature for 3s and then turn back to display set temperature.

Under this mode, indoor fan operates at set fan speed. Compressor, outdoor fan, 4-way valve and electric heating tube stop operation. Indoor fan can be selected to operate at high, medium, low or auto fan speed. Temperature setting range is 60.8~86.0°F.

(12) Off-peak energization function:

This is a time delay to let the compressor equalize pressure. 180 is 3 minutes. 195 is 3 minutes and 15 seconds.

(13) SE control mode

The unit operates at SE status.

(14) X-fan mode

When X-fan function is turned on, after turning off the unit, indoor fan will still operate at low speed for 2min and then the complete unit will be turned off. When x-fan function is turned off, after turning off the unit, the complete unit will be turned off directly.

(15) 46.4°F (8°C) heating function

Under heating mode, you can set the 46.4°F (8°C) heating function by remote controller. The system will operate at 46.4°F (8°C) set temperature.

(16) Turbo fan control function

Set turbo function under cooling or heating mode to enter into turbo fan speed. Press fan speed button to cancel turbo air.

No turbo function under auto, dry or fan mode.

Outdoor Units

1. Input Parameter Compensation and Calibration

(1) Check the indoor ambient temperature compensation function.

a. In cooling mode, the indoor ambient temperature participating in computing control = (T_{indoor ambient temperature} - Δ T_{cooling indoor ambient temperature compensation})

b. In heating mode, the indoor ambient temperature participating in computing control = (T_{indoor ambient temperature} - Δ T_{heating indoor ambient temperature compensation})

(2) Check effective judgment controls of parameters

Effective judgment function of the outdoor exhaust temperature thermo-bulb. When conditions a and b are satisfied, the outdoor exhaust temperature thermo-bulb is judged not to be connected into place, the mainboard of outer units will display failure of the outdoor exhaust temperature thermo-bulb (not connected into place), stop the machine for repairing, and resume the machine by remote controls of ON/OFF.

a. Judgment of exhaust detection temperature change:

After the compressor starts up and runs for 10 minutes, if the compressor frequency $f \geq 40\text{Hz}$, and the rising value T_{exhaust} (T_{exhaust} (after start-up for 10 minutes) - T_{exhaust} (before start-up)) $< 35.6^\circ\text{F}$, the outdoor exhaust temperature thermo-bulb can be judged not to be connected into place (judging once when the power is on the first time).

b. Comparative judgment of exhaust detection temperature and condenser detection temperature (T_{pipe temperature} = T_{outdoor pipe temperature} in cooling mode, T_{pipe temperature} = T_{indoor pipe temperature} in heating mode): After the compressor starts up and runs for 10 minutes, if the compressor frequency $f \geq 40\text{Hz}$, and T_{pipe temperature} $\geq (T_{\text{exhaust}} + 37.4)$, the outdoor exhaust temperature thermo-bulb can be judged not to be connected into place (judging once when power is on the first time).

2. Basic Functions

(1) Cooling Mode

1. Conditions and processes of cooling operation:

(1) If the compressor is shut down, and $[T_{\text{setup}} - (T_{\text{indoor ambient temperature}} - \Delta T_{\text{cooling indoor ambient temperature compensation}})] \leq 32.9^\circ\text{F}$, start up the machine for cooling, the cooling operation will start.

(2) During operations of cooling, if $32^\circ\text{F} \leq [T_{\text{setup}} - (T_{\text{indoor ambient temperature}} - \Delta T_{\text{cooling indoor ambient temperature compensation}})] < 35.6^\circ\text{F}$, the cooling operation will be still running.

(3) During operations of cooling, if $35.6^\circ\text{F} \leq [T_{\text{setup}} - (T_{\text{indoor ambient temperature}} - \Delta T_{\text{cooling indoor ambient temperature compensation}})]$, the cooling operation will stop after reaching the temperature point.

2. Temperature setting range

(1) If T_{outdoor ambient temperature} $\geq [T_{\text{low-temperature cooling temperature}}]$, the temperature can be set at: 60.8~86°F (Cooling at room temperature);

(2) If T_{outdoor ambient temperature} $< [T_{\text{low-temperature cooling temperature}}]$, the temperature can be set at: 77~86°F (Cooling at low temperature), that is, the minimum setting temperature for outer units judgment is 77°F.

(2) Dehumidifying Mode

1. Conditions and processes of dehumidifying operations: Same as the cooling mode.

2. The temperature setting range is: 60.8~86°F.

(3) Air-supplying Mode

1. The compressor, outdoor fans and four-way valves are switched off.

2. The temperature setting range is: 60.8~86°F.

(4) Heating Mode

1. Conditions and processes of heating operations: (T_{indoor ambient temperature} is the actual detection temperature of indoor environment thermo-bulb, T_{heating indoor ambient temperature compensation} is the indoor ambient temperature compensation during heating operations)

(1) If the compressor is shut down, and $[(T_{\text{indoor ambient temperature}} - \Delta T_{\text{heating indoor ambient temperature compensation}}) - T_{\text{setup}}] \leq 32.9^\circ\text{F}$, start the machine to enter into heating operations for heating.

(2) During operations of heating, if $32^\circ\text{F} \leq [(T_{\text{indoor ambient temperature}} - \Delta T_{\text{heating indoor ambient temperature compensation}}) - T_{\text{setup}}] < 35.6^\circ\text{F}$, the heating operation will be still running.

(3) During operations of heating, if $35.6^\circ\text{F} \leq [(T_{\text{indoor ambient temperature}} - \Delta T_{\text{heating indoor ambient temperature compensation}}) - T_{\text{setup}}]$, the heating operation will stop after reaching the temperature point.

2. The temperature setting range in this mode is: 60.8~86°F.

3. Special Functions

Defrosting Control

① Conditions for starting defrosting

After the time for defrosting is judged to be satisfied, if the temperature for defrosting is satisfied after detections for continuous 3min, the defrosting operation will start.

② Conditions of finishing defrosting

The defrosting operation can be exited when any of the conditions below is satisfied:

③ $T_{\text{outdoor pipe temperature}} \geq (T_{\text{outdoor ambient temperature}} - [T_{\text{temperature 1 of finishing defrosting}}])$;

④ The continuous running time of defrosting reaches [tmax. defrosting time].

4. Control Logic

(1) Compressor Control

Start the compressor after starting cooling, heating, dehumidifying operations, and the outer fans run for 5s. When the machine is shut down, in safety stops and when switching to air-supplying mode, the compressor will stop immediately. In all modes: Once the compressor starts up, it will not be allowed to stop until having run for the [tmin. compressor running time] (Note: Including cases of shut down when the temperature point is reached, except the cases requiring stopping the compressor such as fault protection, remote shut down, mode switching etc.). In all modes: Once the compressor stops, it can restart after a 3-minute delay (Note: The indoor units have a function of power memory, the machine can be restarted after remote shut down and powering up again without delay).

1. Cooling mode

Start the machine to enter into cooling operation for cooling, the compressor is switched on.

2. Dehumidifying mode

Same as the cooling mode.

3. Air-supplying mode

The compressor is switched off.

4. Heating mode

(1) Start the machine to enter into heating operation for heating, the compressor is switched on.

(2) Defrosting:

a. Defrosting starts: The compressor slows down for 55 seconds.

b. Defrosting ends: The compressor should never stop when coming out of defrost.

(2) Outer Fans Control

Notes:

The airflow can be switched only if the outer fans run for at least 80s in each airflow speed.

After the outer fans run in high speed for 80s when the machine starts up, control the airflow according to the logic.

After remote shut down, safety stops, and when the machine stops after reaching the temperature point, as well as after the compressor stops, extend 1 minute, and the outer fans will stop (During the 1min period, the airflow of outer fans can be changed according to the outdoor ambient temperature changes). When running with force, the outdoor fans will run in the highest air flow.

(3) 4-way valve control

1. The 4-way valve control under the modes of cooling, dehumidification and supplying air: closing.

2. The status of 4-way valve control under the heating mode: getting power.

(1) 4-way valve power control under heating mode

a. Starts the machine under heating mode, the 4-way valve will be energized immediately.

(2) 4-way valve power turn-off control under heating mode

a. When you should turn off the power or switch to other modes under heating mode, the power of 4-way valve will be cut after 2 minutes of the compressor stopping.

(4) Evaporator freeze-preventing protection function

At the mode of cooling, dehumidifying:

Evaporator freeze-preventing protection function is allowed to begin after 6 min of starting the compressor.

1. Starting estimation:

After the compressor stops working for 180s, if $T_{\text{inner pipe}} > [T_{\text{frozen-preventing frequency-limited temperature}}$ (the temperature of hysteresis is 35.6°F), the machine is only allowed to start for operating, otherwise it should not be started, and should be stopped to treat according to the freeze-preventing protection: Clear the trouble under the mode of power turn-off / heating, and the protection times are not counted.

2. Frequency limited

If $[T_{\text{frozen-preventing normal speed frequency-reducing temperature}}] \leq [T_{\text{inner pipe T frozen-preventing frequency-limited temperature}}]$, you should limit the frequency raising of compressor.

3. Reducing frequency at normal speed:

If $[T_{\text{frozen-preventing high speed frequency-reducing temperature}}] \leq [T_{\text{inner pipe T frozen-preventing normal speed frequency-reducing temperature}}]$, you should adjust the compressor frequency by reducing 8Hz/90s until reaching the lower limit;

4. Reducing frequency at high speed:

If $[T_{\text{freeze-preventing power turn-off temperature}}] \leq T_{\text{inner pipe}} [T_{\text{freeze-preventing high speed frequency-reducing temperature}}]$ you should adjust the compressor frequency by reducing 30Hz/90s until reaching the lower limit;

5. Power turn-off:

If the $T_{\text{inner pipe}} < [T_{\text{freeze-preventing power turn-off temperature}}]$, then freeze-preventing protect to stop the machine; If $T_{\text{frozen-preventing frequency-limited temperature}} < T_{\text{inner pipe}}$, and the compressor has stopped working for 3 minutes, the whole machine should be allowed to operate.

6. If the frozen-preventing protection power turn-off continuously occurs for six times, it should not be resumed automatically, and you should press the ON/OFF button to resume if the fault continues. During the process of running, if the running time of compressor exceeds the t evaporator freeze-preventing protection times zero clearing time, the times of freeze-preventing power turn-off should be cleared to recount. The mode of stopping the machine or transferring to supply air will clear the problem times immediately (if the trouble can not be resumed, mode transferring will not clear it).

(5) Overload protection function

Overload protection function at the mode of cooling and dehumidifying

1. Starting estimation:

After the compressor stops working for 180s, if $T_{\text{outer pipe}} < [T_{\text{cooling overload frequency-limited temperature}}]$ (the temperature of hysteresis is 35.6°F), the machine can start; otherwise it should not be started, and should be stopped to treat according to the overload protection: Clear the trouble at the mode of power turn-off / heating, and the protection times are not counted.

2. Frequency limited

If $[T_{\text{cooling overload frequency-limited temperature}}] \leq [T_{\text{outer pipe T Cooling overload frequency reducing temperature at normal speed}}]$, you should limit the frequency raising of compressor.

3. Reducing frequency at normal speed and power turn-off:

If $[T_{\text{cooling overload frequency reducing temperature at high speed}}] \leq T_{\text{outer pipe}} < [T_{\text{cooling overload power turn-off temperature}}]$, you should adjust the compressor frequency by reducing 8Hz/90s until the lower limit; After it was running 90s at the lower limit, if $[T_{\text{cooling overload frequency reducing temperature at normal speed}}] \leq T_{\text{outer pipe}}$, then cooling overload protects machine stopping;

4. Reducing frequency at high speed and stop machine:

If $[T_{\text{cooling overload frequency reducing temperature at high speed}}] \leq T_{\text{outer pipe}} [T_{\text{cooling overload power turn-off temperature}}]$, you should adjust the compressor frequency by reducing 30Hz/90s till the lower limit; After it was running 90s at the lower limit, if $[T_{\text{cooling overload frequency reducing temperature at normal speed}}] \leq [T_{\text{outer pipe}}]$, then Cooling overload protects machine stopping.

5. Power turn-off:

If the $[T_{\text{cooling overload power turn-off temperature}}] \leq T_{\text{outer pipe}}$, then cooling overload protects machine stopping; If $[T_{\text{outer pipe}}] < [T_{\text{cooling overload frequency-limited temperature}}]$ and the compressor has stopped working for 3 minutes, the machine can operate.

6. If the cooling overload protection power turn-off continuously occurs for six times, it should not be resumed automatically, and you should press the ON/OFF button to resume if the fault continues. During the process of running, if the running time of compressor exceeds the t overload protection times zero clearing time, the times of overload protection power turn-off should be cleared to recount. The mode of stopping the machine or transferring to supply air will clear the trouble times immediately (if the trouble can not be resumed, transferring mode will not clear it).

Overload protection function at the mode of heating**Starting estimation :**

After the compressor stops working for 180s, if $T_{\text{inner pipe}} > T_{\text{heating overload frequency-limited temperature}}$ (the temperature of hysteresis is 35.6°F), the machine is allowed to start, otherwise it should not be started, and should be stopped to treat according to the overload protection:

Clear the trouble at the mode of power turn-off / heating, and the protection times are not counted.

1. Frequency limited

If $[T_{\text{heating overload frequency-limited temperature}}] \leq T_{\text{inner pipe}} < [T_{\text{heating overload frequency reducing temperature at normal speed}}]$, you should limit the frequency raising of compressor.

2. Reducing frequency at normal speed and stopping machine:

If $T_{\text{heating overload frequency reducing temperature at normal speed}} \leq T_{\text{inner pipe}} < [T_{\text{heating overload frequency reducing temperature at high speed}}]$, you should adjust the compressor frequency by reducing 8Hz/90s till the lower limit. After it runs 90s at the lower limit, if $T_{\text{heating overload frequency reducing temperature at normal speed}} \leq T_{\text{inner pipe}}$, then overload protects machine stopping.

3. Reducing frequency at high speed and power turn-off:

If $[T_{\text{heating overload frequency reducing temperature at high speed}}] \leq T_{\text{inner pipe}} < [T_{\text{heating overload power turn-off temperature}}]$, you should adjust the compressor frequency by reducing 30Hz/90s until the lower limit. After it runs 90s at the lower limit, if $T_{\text{heating overload frequency reducing temperature at normal speed}} \leq T_{\text{outer pipe}}$, then cooling overload protects machine stopping.

4. Power turn-off:

If the $[T_{\text{heating overload power turn-off temperature}}] \leq T_{\text{inner pipe}}$, then overload protects machine stopping; If $T_{\text{inner pipe}} > T_{\text{heating overload frequency-limited temperature}}$ and the compressor has been stopped working for 3 minutes, the machine should be allowed to operate.

5. If the overload protection power turn-off continuously occurs for six times, it should not be resumed automatically, and you should press the ON/OFF button to resume if the fault continues. During the process of running, if the running time of compressor exceeds the $t_{\text{overload protection times zero clearing time}}$, the times of overload protection power turn-off should be cleared to recount. The mode of stopping the machine or transferring to supply air will clear the problem times immediately (if the trouble can not be resumed, transferring mode will not clear it). Protective function for discharge temperature of compressor.

1. Starting estimation:

After the compressor stopped working for 180s, if $T_{\text{Discharge}} < T_{\text{Discharge limited temperature}}$ (the temperature of hysteresis is 35.6°F), the machine can start. Otherwise it should not be started, and should be stopped to treat according to the discharge temperature:

The machine should be stopped or transferred to supply air, the trouble should be cleared immediately, and the protection times are not counted.

2. Frequency limited

If $[T_{\text{limited frequency temperature during discharging}}] \leq T_{\text{Discharge}} < [T_{\text{frequency reducing temperature at normal speed during discharging}}]$, you should limit the frequency raising of compressor.

3. Reducing frequency at normal speed and stopping machine:

If $[T_{\text{frequency reducing temperature at normal speed during discharging}}] \leq T_{\text{Discharge}} < [T_{\text{frequency reducing temperature at high speed during discharging}}]$, you should adjust the compressor frequency by reducing 8Hz/90s till the lower limit. After it was running 90s at the lower limit, if $[T_{\text{frequency reducing temperature at normal speed during discharging}}] \leq T_{\text{Discharge}}$, you should discharge to protect machine stopping.

4. Reducing frequency at high speed and power turn-off:

If $[T_{\text{frequency reducing temperature at high speed during discharging}}] \leq T_{\text{Discharge}} < [T_{\text{Stop temperature during discharging}}]$, you should adjust the compressor frequency by reducing 30Hz/90s till the lower limit; After it was running 90s at the lower limit, if $[T_{\text{frequency reducing temperature at normal speed during discharging}}] \leq T_{\text{Discharge}}$, you should discharge to protect machine stopping.

5. Power turn-off:

If the $[T_{\text{Power turn-off temperature during discharging}}] \leq T_{\text{Discharge}}$, you should discharge to protect machine stopping. If $T_{\text{Discharge}} < [T_{\text{limited frequency temperature during discharging}}]$ and the compressor has been stopped for 3 minutes, the machine should be allowed to operate.

6. If the discharging temperature protection of compressor continuously occurs for six times, it should not be resumed automatically, and you should press the ON/OFF button to resume. During the process of running, if the running time of compressor exceeds the $t_{\text{Protection times clearing of discharge}}$, the discharge protection is cleared to recount. Stopped or transferred to supply air mode will clear the trouble times immediately (if the trouble can not be resumed, mode transferring also will not clear it).

7. Frequency limited

If $[I_{\text{limited frequency when overcurrent}}] \leq I_{\text{AC Electric current}} < [I_{\text{frequency reducing when overcurrent}}]$, you should limit the frequency raising of compressor.

8. Reducing frequency:

If $[I_{\text{frequency reducing when overcurrent}}] \leq [I_{\text{AC Electric current}}]$ Power turn-off when overcurrent], you should reduce the compressor frequency until reaching the lower limit or exit the frequency reducing condition.

9. Power turn-off:

If $[I_{\text{Power turn-off machine when overcurrent}}] \leq [I_{\text{AC Electric current}}]$, you should carry out the overcurrent stopping protection. If $I_{\text{AC Electric current}} < [I_{\text{limited frequency when overcurrent}}]$ and the compressor has been stopped for 3 minutes, the machine can operate.

10. If the overcurrent protection continuously occurs for six times, it should not be resumed automatically, and you should press the ON/OFF button to resume. During the process of running, if the running time of compressor exceeds the $[t_{\text{Protection times clearing of over current}}]$, the discharge protection is cleared to recount.

(6) Voltage sag protection

After start the compressor, if the time of DC link Voltage sag [$U_{\text{Sagging protection voltage}}$] is measured to be less than t Voltage sag protection time, the machine should be stopped at once, hand on the voltage sag trouble, reboot automatically after 30 minutes.

(7) Communication fault

When you have not received any correct signal from the inner machine in three minutes, the machine will stop for communication fault. When you have not received any correct signal from driver IC (aim to the controller for the separating of main control IC and driver IC), and the machine will stop for communication fault. If the communication is resumed, the machine will be allowed to operate.

(8) Module protection

Testing the module protective signal immediately after started, once the module protective signal is measured, stop the machine with module protection immediately. If the module protection is resumed, the machine will be allowed to operate. If the module protection continuously occurs for three times, it should not be resumed automatically, and you should press the ON/OFF button to resume. If the running time of compressor exceeds the [$t_{\text{Protection times clearing of module}}$], the module protection is cleared to recount.

(9) Module overheating protection

1. Starting estimation:

After the compressor stops working for 180s, if $T_{\text{Module}} < [T_{\text{Module frequency limited temperature}}]$ (the temperature of hysteresis is 35.6°F), the machine is allowed to start. Otherwise it should not be started, and should be stopped to treat according to the module overheating protection: The machine should be stopped or transferred to supply air, the trouble should be cleared immediately, and the protection times are not counted.

2. Frequency limited

If $[T_{\text{Limited frequency temperature of module}}] \leq T_{\text{Module}} < [T_{\text{frequency reducing temperature at normal speed of module}}]$, you should limit the frequency raising of compressor.

3. Reducing frequency at normal speed and power turn-off:

If $[T_{\text{frequency reducing temperature at normal speed of module}}] \leq T_{\text{Module}} < [T_{\text{frequency reducing temperature at high speed of module}}]$, you should adjust the compressor frequency by reducing 8Hz/90s until the lower limit. After it was running 90s at the lower limit, if $[T_{\text{frequency reducing temperature at normal speed of module}}] \leq T_{\text{Module}}$, you should stop the machine for module overheating protection.

4. Reducing frequency at high speed and power turn-off:

If $[T_{\text{frequency reducing temperature at high speed of module}}] \leq T_{\text{Module}} < [T_{\text{Power turn-off temperature of module}}]$ you should adjust the compressor frequency by reducing 30Hz/90s until the lower limit. After it was running 90s at the lower limit, if $[T_{\text{frequency reducing temperature at normal speed of module}}] \leq T_{\text{Module}}$, you should stop the machine for module overheating protection.

5. Power turn-off:

If the $[T_{\text{Power turn-off temperature of module}}] \leq T_{\text{Module}}$, you should stop the machine for module overheating protection. If $T_{\text{Module}} < [T_{\text{Limited frequency temperature of module}}]$ and the compressor has been stopped for 3 minutes, the machine should be allowed to operate.

6. If protection continuously occurs for six times, it should not be resumed automatically, and you should press the ON/OFF button to resume. During the process of running, if the running time of compressor exceeds the [$t_{\text{Protection times clearing of module}}$], the discharge protection is cleared to recount. Stopped or transferred to supply air mode will clear the trouble times immediately (if the trouble can not be resumed, mode transferring also will not clear it).

(10) Compressor overloads protection

If you measure the compressor overload switch action in 3s, the compressor should be stopped for overloading. The machine should be allowed to operate after overload protection was measured to resume. If the overloading protection continuously occurs three times, it should not be resumed automatically, and you should press the ON/OFF button to resume. The protection times of compressor is allowed to clear after the compressor run [$t_{\text{Protection times clearing of compressor overloading}}$] 30 minutes.

(11) Phase current overcurrent protection of compressor

During the running process of compressor, you could measure the phase current of the compressor, and control it according to the following steps:

1. Frequency limited

If $[I_{\text{Limited frequency phase current}}] \leq [I_{\text{Phase current T frequency reducing phase current}}]$, you should limit the frequency raising of compressor.

2. Reducing Frequency

If $[I_{\text{Frequency Reducing Phase Current}}] \leq I_{\text{Phase Current}} < [I_{\text{Power Turn-Off Phase Current}}]$, the compressor shall continue to reduce frequency till the lowest frequency limit or out of the condition of reducing frequency.

3. Power turn-off

If $[I_{\text{Phase Current}}] \geq [I_{\text{Power Turn-Off Phase Current}}]$, the compressor phase current stops working for overcurrent protection; if $[I_{\text{Phase Current}}] \leq [I_{\text{Frequency Reducing Phase Current}}]$, and the compressor have stopped working for 3 min, the machine can operate;

4. If the overcurrent protection of compressor phase current continuously occurs for six times, it should not be resumed automatically, and you should press the ON/OFF button to resume. During the process of running, if the running time of compressor exceeds the [$t_{\text{Clearing Time of Compressor Phase Current Times}}$], the overcurrent protection is cleared to recount.

(12) Starting-up Failure Protection for Compressor

Stop the compressor after its start-up fails, restart it after 20s if the fault doesn't show, and if they are all failing for successive starts three times, it shall be reported as Start-up Failure, and then restart it after three min. When it still doesn't operate after carrying out the above process for five times, it is available if pressing ON/OFF. And the compressor should be cleared the times after it runs 2 min.

(13) Out-of-Step Protection for Compressor

The out-of-step protection signal should be detected immediately after starting-up compressor, and once finding the out-of-step protection signal, the out-of-step protection should be stopped. If it can run for lasting power turn-off 3 min, the machine should be allowed to operate. If it still can't run automatically when the out-of-step protection for compressor happens to stop working for six times in succession, it needs pressing ON/OFF to operate. And if the running time is more than 10 min, the power turn-off times for out-of-step protection shall be cleared and recounted.

(14) Voltage Abnormity Protection for DC Bus

To detect voltage abnormality protection for dc bus after completing the pre-charge:

1. Over-High voltage protection for DC Bus:

If it found the DCbus voltage $U_{DC} > [U_{DC} \text{ Jiekuangchun Protection}]$, turn off PFC and stop the compressor at once, and it shall show the DC over-high voltage failure; it should clear out the failure when the voltage dropped to $U_{DC} < [U_{DC} \text{ Jiekuangchun Recovery}]$ and the compressor stopped for 3 min.

2. Over-Low Voltage Protection for DC Bus:

If it found the DC bus voltage $U_{DC} < [U_{DC} \text{ Wantuochun Protection}]$, turn off PFC and stop the compressor at once, and it shall show the DC over-low voltage; and it should clear out the failure when the voltage raised to $U_{DC} > [U_{DC} \text{ Wantuochun Recovery}]$ and the compressor stopped for 3 min.

3. To detect voltage abnormity protect for DC bus when getting electricity:

If it found the DC bus voltage $U_{DC} > [U_{DC} \text{---Over-High Voltage}]$, turn off the relay at once, and shows voltage abnormity failure for DC Bus. And the failure can't recover except to break off and get the electricity.

(15) Abnormity Protection for Four-way Valve

Under the model of heating operation in good condition: the compressor is detected $[T_{\text{Inner Tube}} < (T_{\text{Inner Ring}} - T_{\text{Abnormity Temperature Difference For Four-Way Valve Reversion}})]$, during the running, it should be regarded as four-way valve reversion abnormality. And then it can run if stopping the reversion abnormality protection for four-way valve 3 min; and if it still can't run when the reversion abnormality protection for four-way valve happens to stop working for three times in succession, it is available if pressing ON/OFF.

Attention: The protection should be shielded during the testing mode and defrosting process, and it should clear out the failure and its times immediately when turning off or delivering wind / cooling / dehumidifying mode conversed (the inverted mode doesn't clear out the failure when it can't recover to operate).

(16) PFC Protection

1. After starting up the PFC, it should detect the protection signal of PFC immediately; under the condition of PFC protection, it should turn off the PFC and the compressor at one time.
2. It shows the failure is cleared out if PFC Protection stopped working 3 min and recovers to run automatically.
3. If it still can't run when PFC protection occurs for 3 times in succession, it is available if pressing ON/OFF, and clear the PFC Protection times when start up PFC for 10min.

(17) Failure Detection for Sensor

1. Outdoor Ambient Sensor: Detect the failure of sensor at all times.
2. Outdoor Tube Sensor: You should not detect the failure of outdoor tube sensor within 10 minutes of heating operation of compressor except the defrosting, and you could detect it at another time.
3. Outdoor Exhaust Sensor:
 - (a) The compressor only detects the sensor failure after it starts up 3 min in normal mode.
 - (b) It should detect the exhaust sensor failure immediately in the testing mode.
4. Module Temperature Sensor:
 - (a) Short-Circuit Detection: The compressor should be detected immediately when the module temperature sensor occurs short-circuits.
 - (b) Open-Circuit Detection: The compressor should be detected on open-circuit when it runs 3min. When the discharge sensor opens/shorts in 30 seconds, the system will shut down to keep the compressor from overheating.
 - (c) Detect the sensor failure at all times in the testing mode.

5. Disposal for Sensor Protection

- (1) When the short-circuit of sensor is detected within 30s, it is regarded as the temperature of sensor over-high (or infinitely high), and now according to the over-high sensor, the machine should carry out the corresponding protection to stop working, and show the corresponding temperature shut down protection and sensor failure at the same time. (For example: the compressor stops immediately when the outdoor tube sensor short-circuits, and the machine shows an overload protection and outdoor tube sensor failure).
- (2) When the open-circuit of sensor is detected within 30s, the protection stops and it should show the corresponding sensor failure.

6. Electric Heating Function of Chassis

- (1) When $T_{\text{outdoor amb.}} \leq 32^{\circ}\text{F}$, the electric heating of chassis will operate.
- (2) When $T_{\text{outdoor amb.}} > 35.6^{\circ}\text{F}$, the electric heating of chassis will stop operation.
- (3) When $32^{\circ}\text{F} < T_{\text{outdoor amb.}} \leq 35.6^{\circ}\text{F}$, the electric heating of chassis will keep original status.

7. Electric Heating Function of Compressor

- (1) When $T_{\text{outdoor amb.}} \leq 23^{\circ}\text{F}$, compressor stops operation, while the electric heating of compressor starts operation.
- (2) When $T_{\text{outdoor amb.}} > 28.4^{\circ}\text{F}$, the electric heating of compressor stops operation.
- (3) When $23^{\circ}\text{F} < T_{\text{outdoor amb.}} \leq 28.4^{\circ}\text{F}$, the electric heating of compressor will keep original status.

7. Maintenance

7.1 Precautions before Maintenance

There are high-capacity electrolytic capacitors on the outdoor mainboard. Thus, even if the power is cut off, there is high voltage inside the capacitors and it needs more than 20 min. to reduce the voltage to safety value. Touching the electrolytic capacitor within 20 min. after cutting the power will cause electric shock. If maintenance is needed, follow the steps below to discharge electricity of electrolytic capacitor after power off.

(1) Open the top cover of outdoor unit and then remove the cover of the electric box.

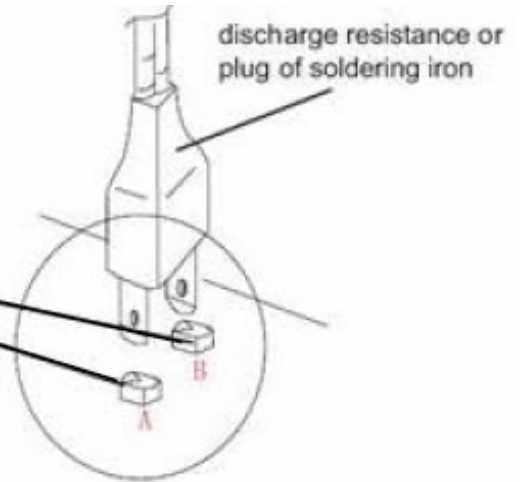
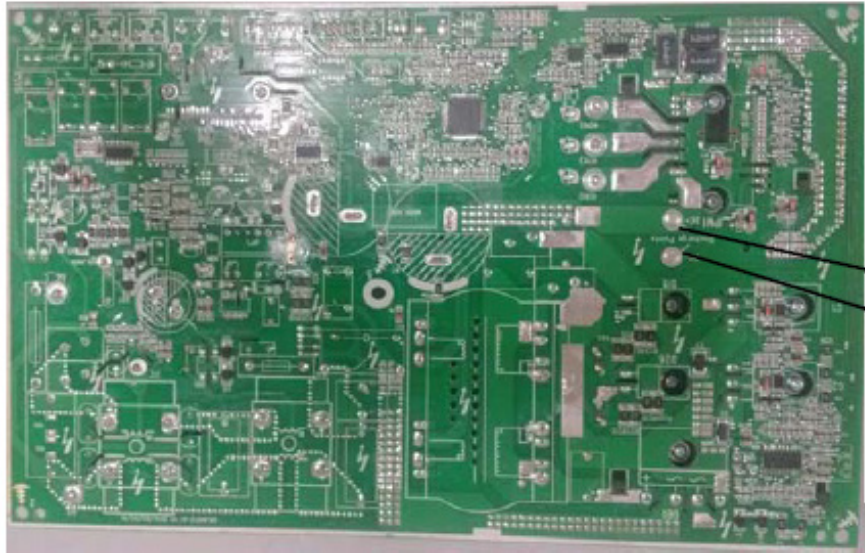
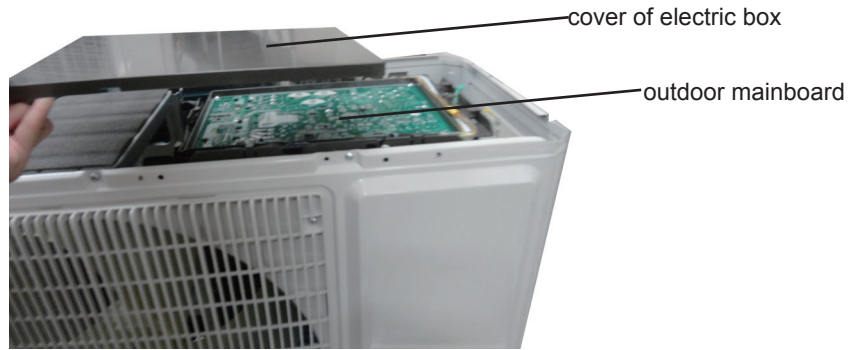

7.2 Error Code List

Name of malfunction	Display of indoor unit	Display of lamp (the times of blinking)					
		Indoor			Outdoor		
		R	C	H	Y	R	G
Anti-freezing protection	E2	2			3		
Block or Low pressure of refrigerant system	E3	3				9	
Compressor exhaust high temperature protection	E4	4			7		
AC over-current protection	E5	5			5		
Communication failure between indoor unit and outdoor unit	E6	6					O/U
Anti-high temperature protection	E8	8			6		
	H4			4	6		
No feedback of indoor fan motor	H6	11					
Jumper cap malfunction protection	C5	15					
Indoor unit and outdoor unit doesn't match	LP	19			16		
Outdoor DC fan motor malfunction	L3	23				14	
Power protection	L9	20			9		
Gathering refrigerant	Fo	1	1				
Indoor ambient sensor open or short circuit	F1		1				
Indoor tube sensor open or short circuit	F2		2				
Outdoor ambient sensor open or short circuit	F3		3			6	
Outdoor tube sensor open or short circuit	F4		4			5	
Exhaust sensor open or short circuit	F5		5			7	
Overload limit / drop frequency	F6		6			3	
Over current limit / drop frequency	F8		8			1	
High exhaust temperature limit / drop frequency	F9		9			2	
Refrigerant leakage protection	F0		10			9	
Anti-freezing limit / drop frequency	FH		2	2		4	
Defrosting	H1			1	2		
Compressor overload protection	H3			3	8		
IPM protection	H5			5	4		
Module temperature is too high	H5			5	10		
PFC protection	HC			6	14		
Loading EEPROM malfunction	EE			15	11		
High PN voltage protection	PH		11		13		
Low PN voltage protection	PL			21	12		
4-way valve reversal abnormal	U7		20				
DRED1 / DRED2 / DRED3	d1/d2/d3						
Compressor Min frequency in test state	P0						
Compressor rated frequency in test state	P1						
Compressor maximum frequency in test state	P2						
Compressor intermediate frequency in test state	P3						
Compressor is running(normal)					1		
The temperature for turning on the unit is reached(normal)						8	
Frequency limiting (module temperature)	EU		6	6		11	
Frequency limiting (power)	LU		24			13	

Notes: R(Indoor)--Running C--Cooling H--Heating Y--Yellow R(Outdoor)--Red G--Green

O/U--OFF or Unblink

The display difference between Fo and F0 is 'o' is the bottom part of figure 8



7.3 Troubleshooting for Main Malfunction

•Indoor unit:

1. Malfunction of Temperature Sensor F1, F2

Main detection points:

- Is the wiring terminal between the temperature sensor and the controller loosened or poorly contacted?
- Is there short circuit due to trip-over of the parts?
- Is the temperature sensor broken?
- Is mainboard broken?

Malfunction diagnosis process:

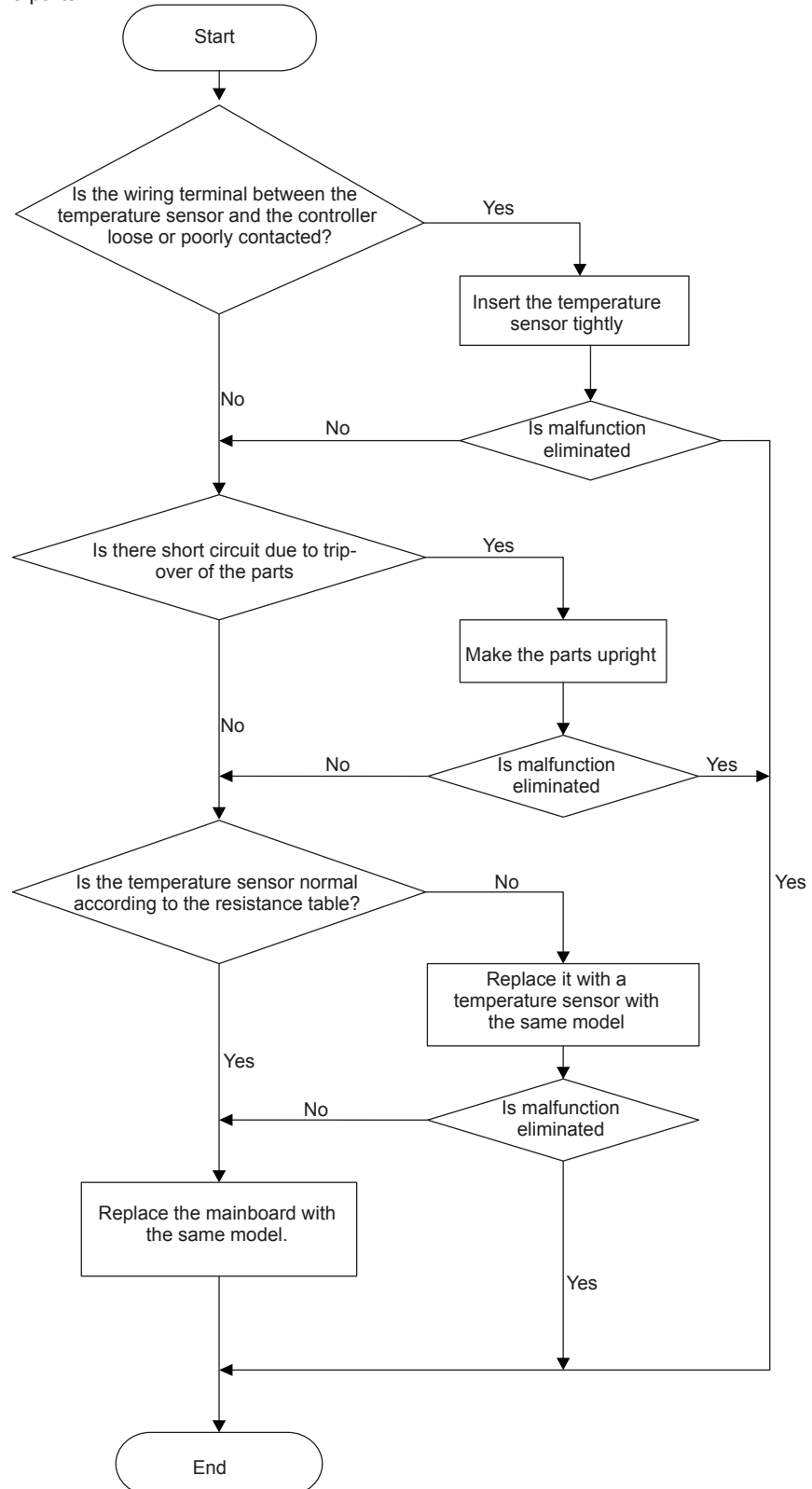

2. Malfunction of Blocked Protection of IDU Fan Motor H6

Main detection points:

- SmoothlyIs the control terminal of PG motor connected tightly?
- SmoothlyIs the feedback interface of PG motor connected tightly?
- The fan motor can't operate?
- The motor is broken?
- Detection circuit of the mainboard is defined abnormal?

Malfunction diagnosis process:

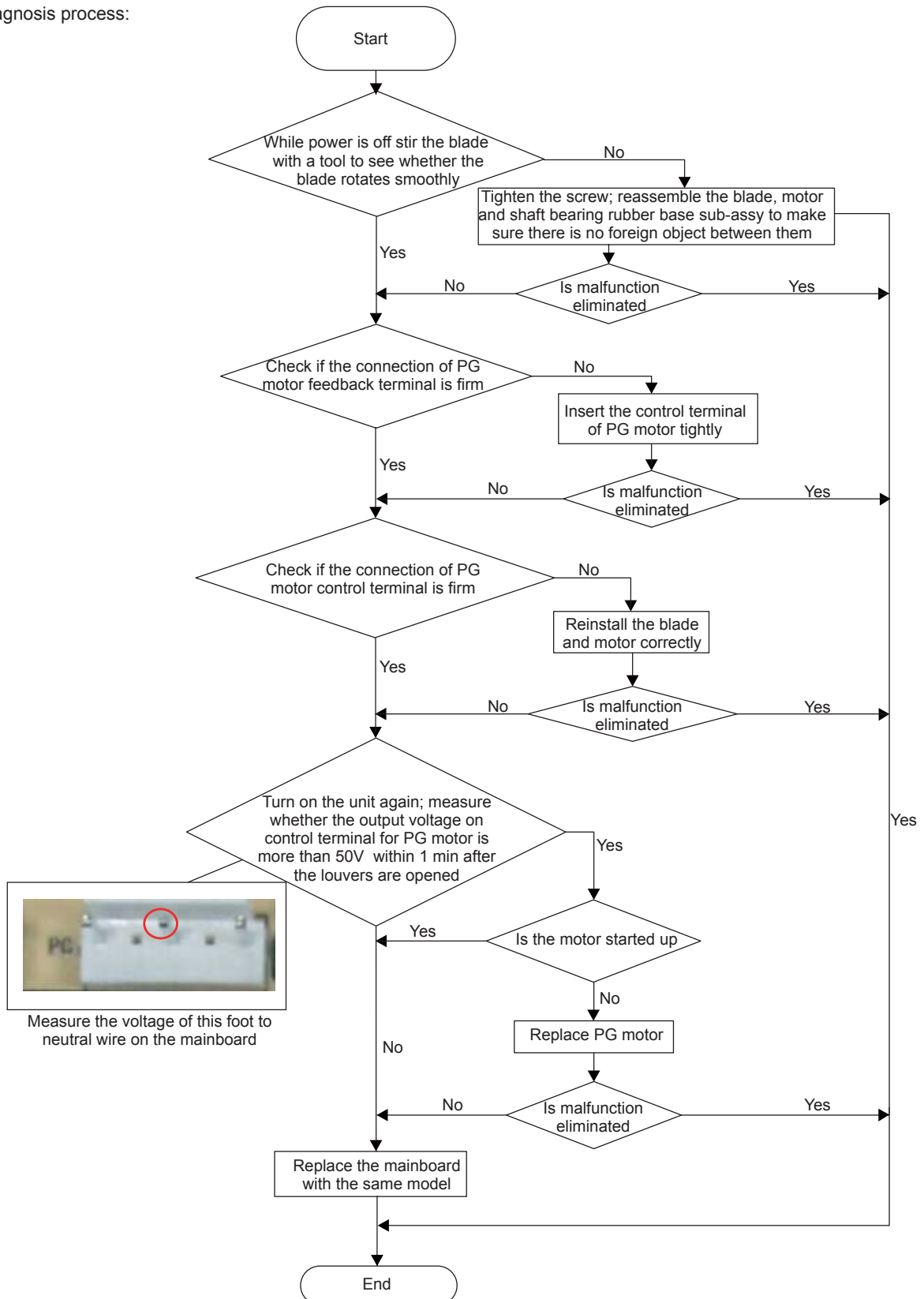

4. Malfunction of Zero-crossing Inspection Circuit Malfunction of the IDU Fan Motor U8

Main detection points:

- Instant energization after de-energization while the capacitor discharges slowly?
- The zero-cross detection circuit of the mainboard is defined abnormal?

Malfunction diagnosis process:

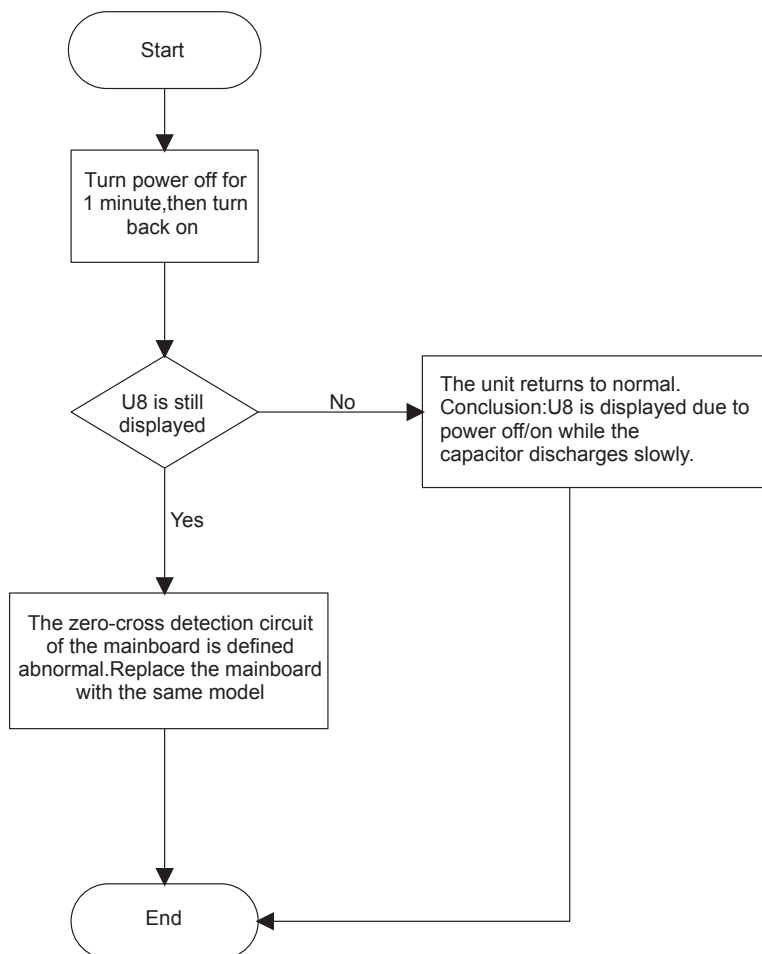

●Outdoor unit:

(1) Capacitor charge fault (Fault with outdoor unit) (AP1 below refers to the outdoor control panel)

Main Check Points:

- Use AC voltmeter to check if the voltage between terminal L and N on the wiring board is within 210VAC~240VAC.
- Is the reactor (L) correctly connected? Is the connection loose or fallen? Is the reactor (L) damaged?

Fault diagnosis process:

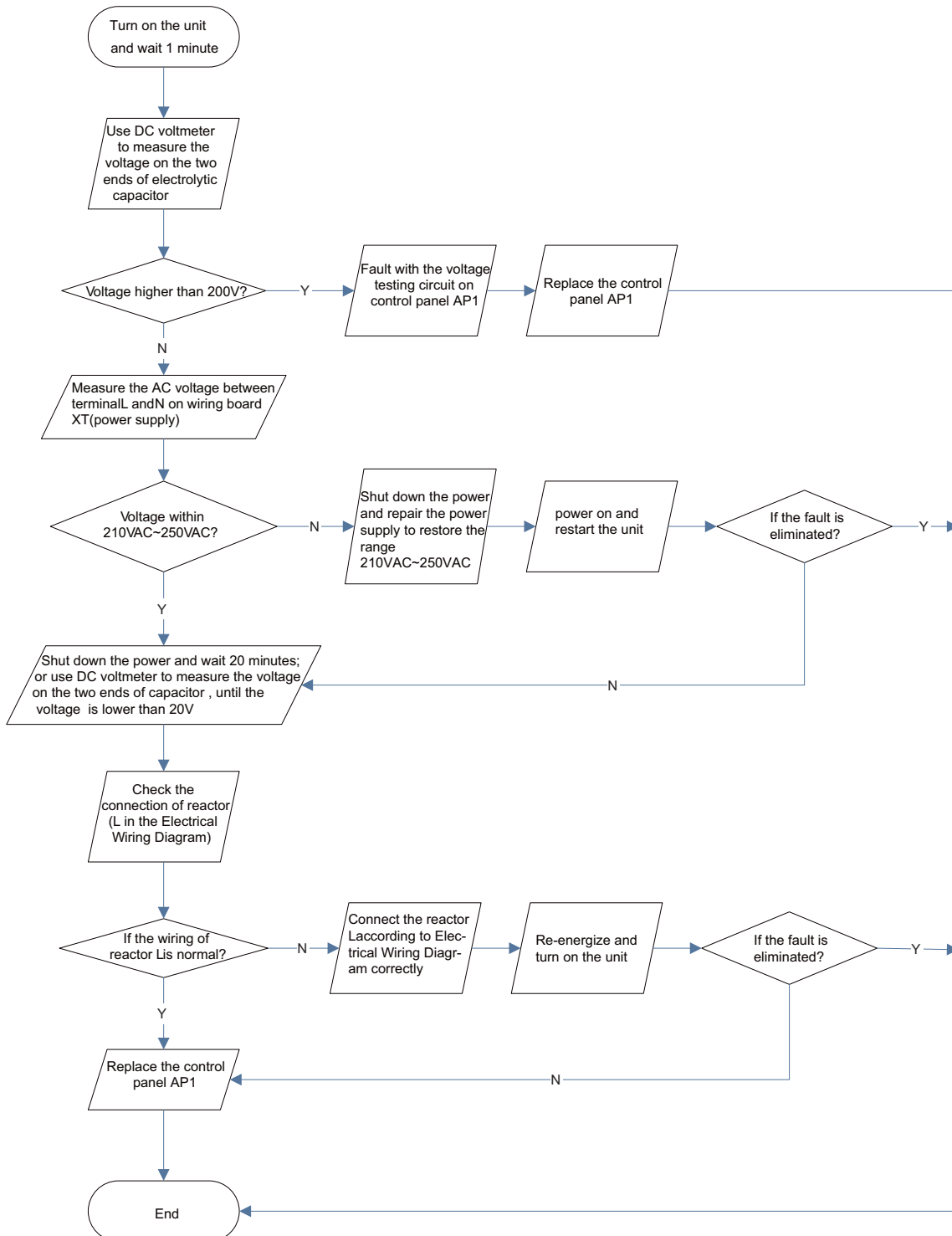

(2) IPM Protection, Out-of-step Fault, Compressor Phase Overcurrent (AP1 below refers to the outdoor control panel)

Main check points:

- Is the connection between control panel AP1 and compressor COMP secure? Loose? Is the connection in correct order?
- Is the voltage input of the machine within normal range? (Use AC voltmeter to measure the voltage between terminal L and N on the wiring board XT)
- Is the compressor coil resistance normal? Is the insulation of compressor coil against the copper tube in good condition?
- Is the working load of the machine too high? Is the radiation good?
- Is the charge volume of refrigerant correct?

Fault diagnosis process:

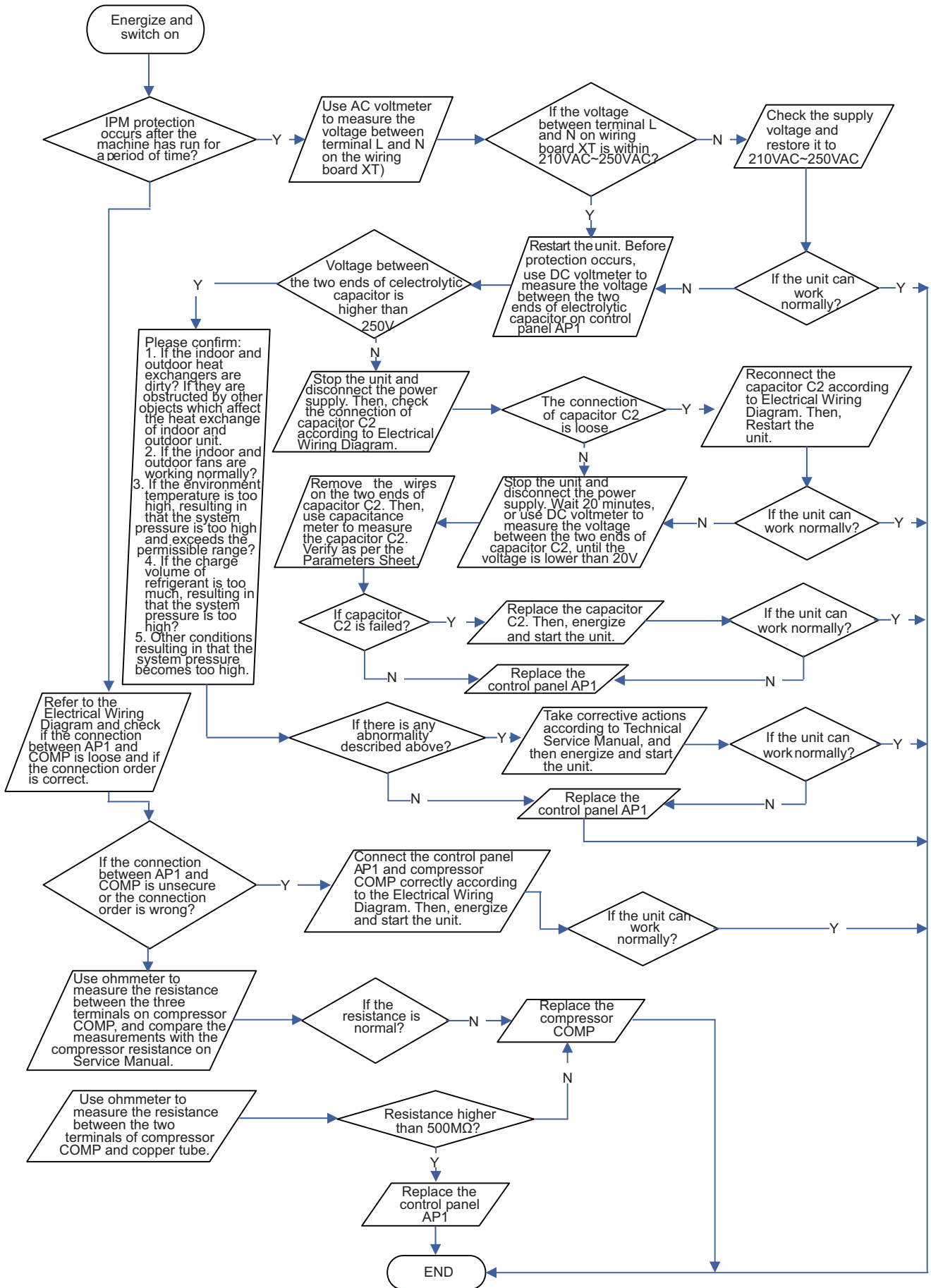

(3) High temperature and overload protection diagnosis (AP1 hereinafter refers to the control board of the outdoor unit)

Mainly detect:

- Is outdoor ambient temperature in normal range?
- Are the outdoor and indoor fans operating normally?
- Is the heat dissipation environment inside and outside the unit good?

Fault diagnosis process:

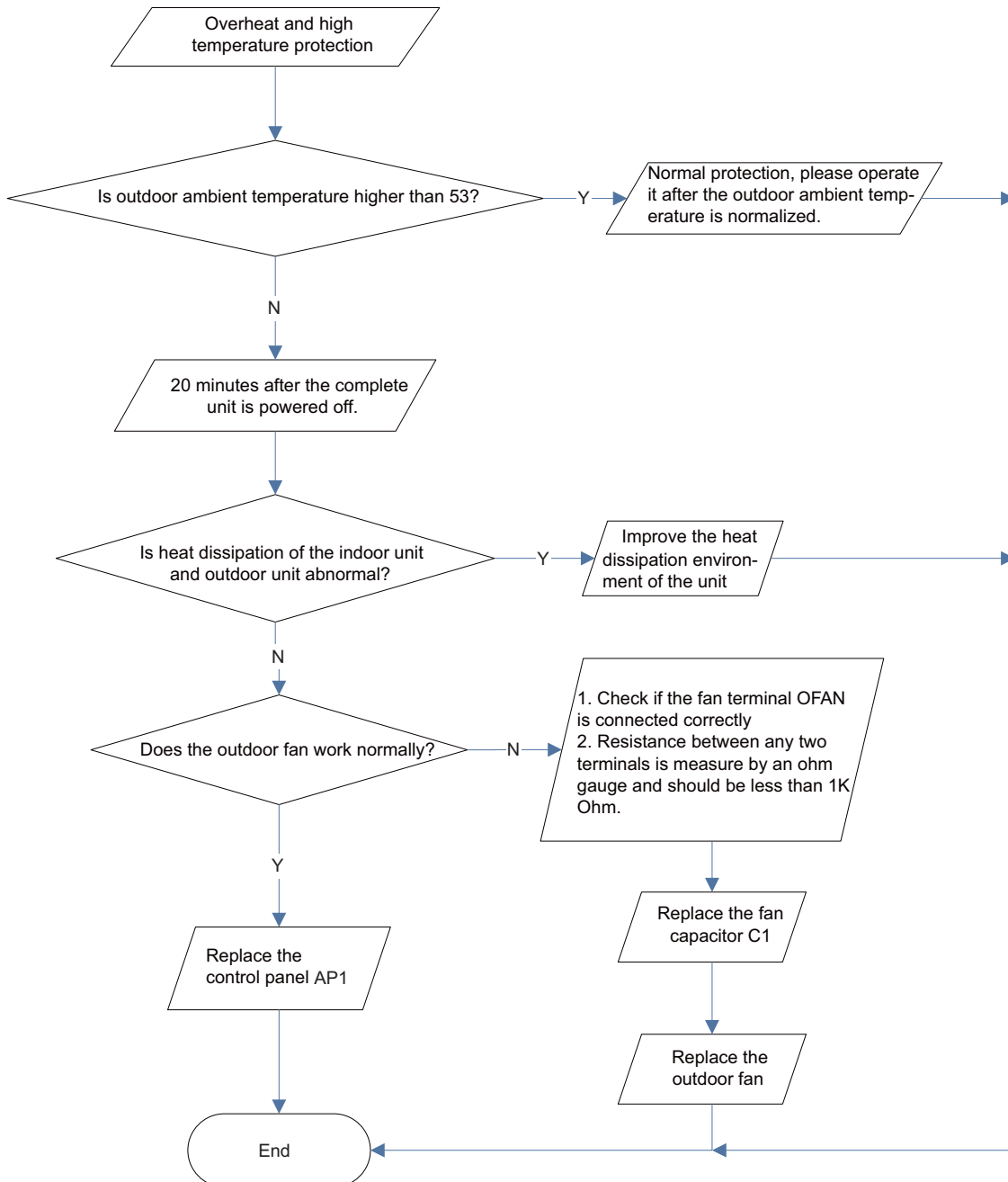

(4) Start-up failure (following AP1 for outdoor unit control board)

Mainly detect:

- Whether the compressor wiring is connected correct?
- Is compressor broken?
- Is time for compressor stopping enough?

Fault diagnosis process:

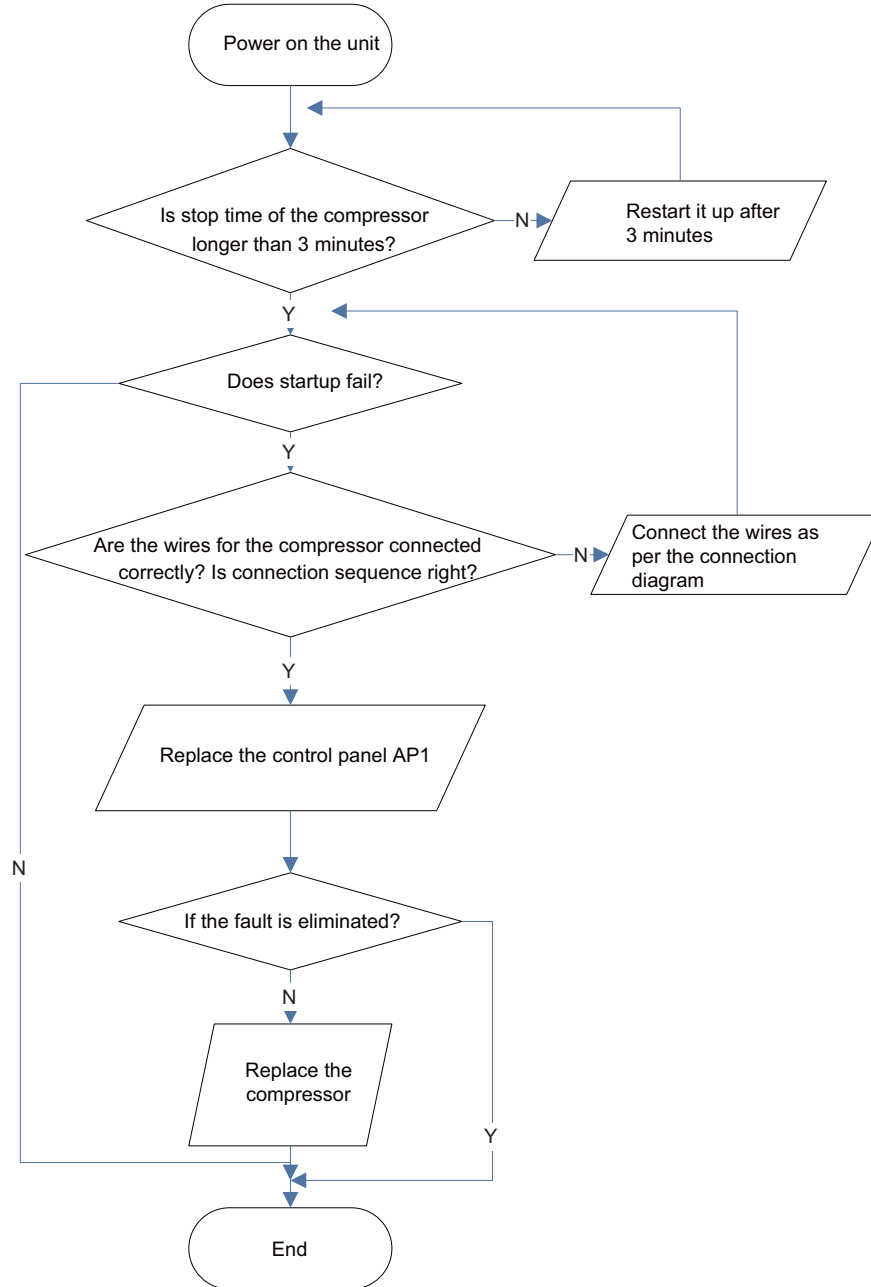

(5) Out of step diagnosis for the compressor (AP1 hereinafter refers to the control board of the outdoor unit)

Mainly detect:

- Is the system pressure too high?
- Is the input voltage too low?

Fault diagnosis process:

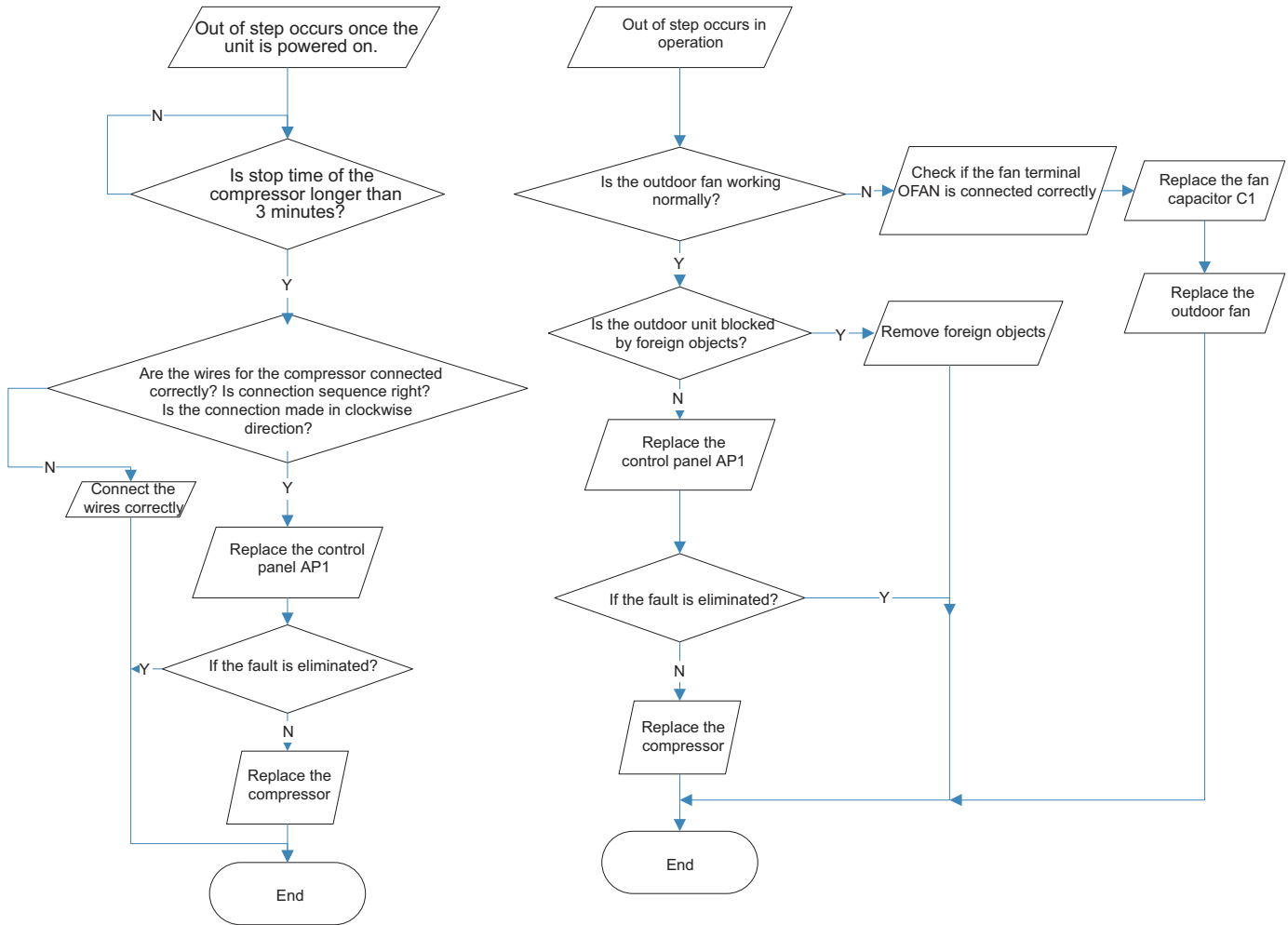

(7) Power factor correct or (PFC) fault (a fault of outdoor unit) (AP1 hereinafter refers to the control board of the outdoor unit)

Mainly detect:

- Check if the reactor (L) of the outdoor unit and the PFC capacitor are broken

Fault diagnosis process:

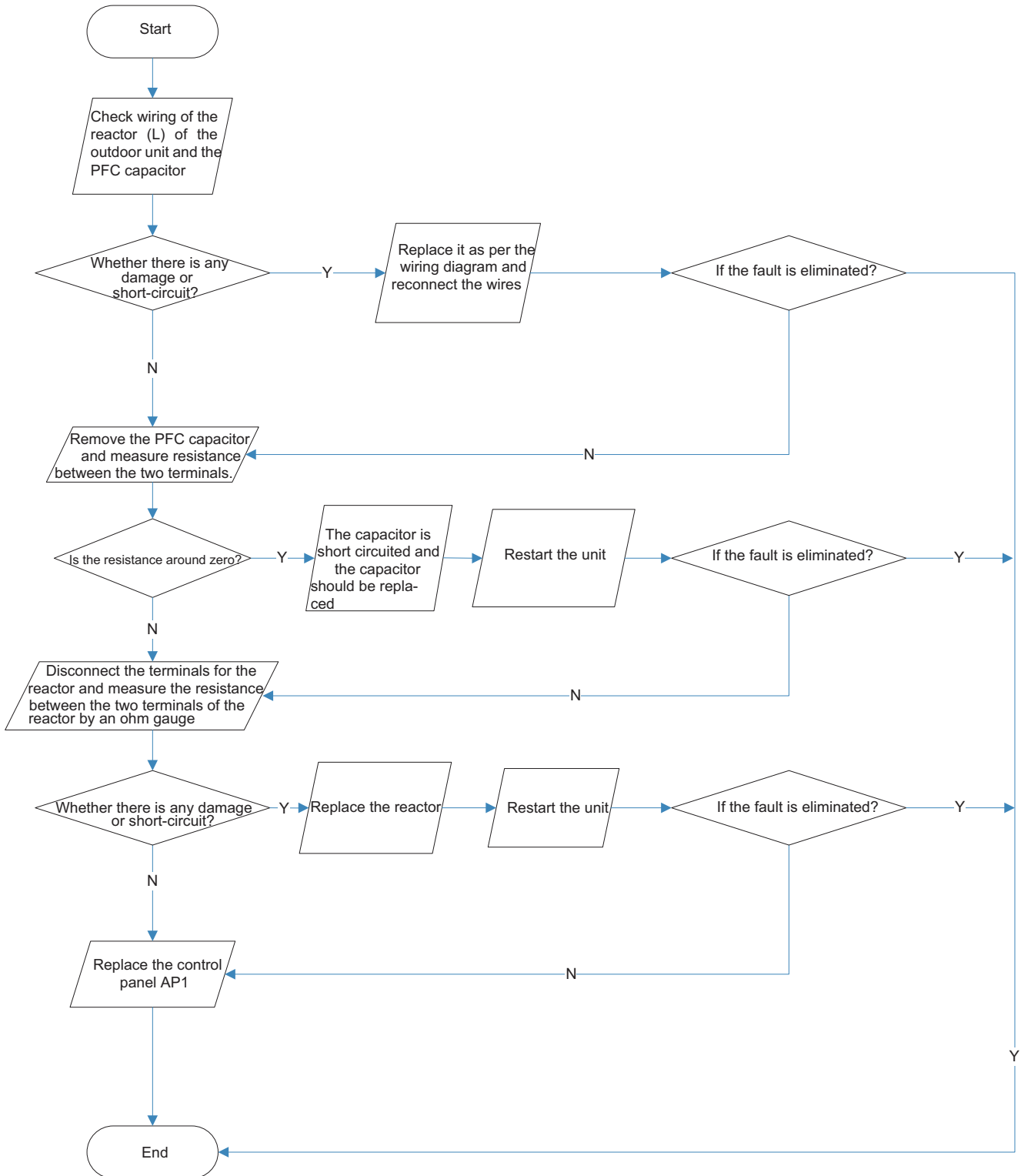

7.4 Troubleshooting for Normal Malfunction

1. Air Conditioner Doesn't Start

Possible Causes	Discriminating Method (Air conditioner Status)	Troubleshooting
No power supply, or poor connection for power plug	After energization, operation indicator isn't bright and the buzzer can't give out sound	Confirm whether it's due to power failure. If yes, wait for power recovery. If not, check power supply circuit and make sure the power plug is connected well.
Wrong wire connection between indoor unit and outdoor unit, or poor connection for wiring terminals	Under normal power supply circumstances, operation indicator isn't bright after energization	Check the circuit according to circuit diagram and connect wires correctly. Make sure all wiring terminals are connected firmly
Electric leakage for air conditioner	After energization, room circuit breaker trips off at once	Make sure the air conditioner is grounded reliably Make sure wires of air conditioner is connected correctly Check the wiring inside air conditioner. Check whether the insulation layer of power cord is damaged; if yes, place the power cord.
Model selection for air switch is improper	After energization, air switch trips off	Select proper air switch
Malfunction of remote controller	After energization, operation indicator is bright, while no display on remote controller or buttons have no action.	Replace batteries for remote controller Repair or replace remote controller

2. Poor Cooling (Heating) for Air Conditioner

Possible Causes	Discriminating Method (Air conditioner Status)	Troubleshooting
Set temperature is improper	Observe the set temperature on remote controller	Adjust the set temperature
Rotation speed of the IDU fan motor is set too low	Small wind blow	Set the fan speed at high or medium
Filter of indoor unit is blocked	Check the filter to see it's blocked	Clean the filter
Installation position for indoor unit and outdoor unit is improper	Check whether the installation position is proper according to installation requirement for air conditioner	Adjust the installation position, and install the rainproof and sunproof for outdoor unit
Refrigerant is leaking	Discharged air temperature during cooling is higher than normal discharged wind temperature; Discharged air temperature during heating is lower than normal discharged wind temperature; Unit's pressure is much lower than regulated range	Find out the leakage causes and deal with it. Add refrigerant.
Malfunction of 4-way valve	Blows cold air during heating	Replace the 4-way valve
Malfunction of capillary	Discharged air temperature during cooling is higher than normal discharged wind temperature; Discharged air temperature during heating is lower than normal discharged wind temperature; Unit's pressure is much lower than regulated range. If refrigerant isn't leaking, part of capillary is blocked	Replace the capillary
Flow volume of valve is insufficient	The pressure of valves is much lower than that stated in the specification	Open the valve completely
Malfunction of horizontal louver	Horizontal louver can't swing	Refer to point 3 of maintenance method for details
Malfunction of the IDU fan motor	The IDU fan motor can't operate	Refer to troubleshooting for H6 for maintenance method in details
Malfunction of the ODU fan motor	The ODU fan motor can't operate	Refer to point 4 of maintenance method for details
Malfunction of compressor	Compressor can't operate	Refer to point 5 of maintenance method for details

3. Horizontal Louver Doesn't Swing

Possible Causes	Discriminating Method (Air conditioner Status)	Troubleshooting
Wrong wire connection, or poor connection	Check the wiring status according to circuit diagram	Connect wires according to wiring diagram to make sure all wiring terminals are connected firmly
Stepping motor is damaged	Stepping motor can't operate	Repair or replace stepping motor
Main board is damaged	Others are all normal, while horizontal louver can't operate	Replace the main board with the same model



4. ODU Fan Motor Doesn't Operate

Possible causes	Discriminating method (air conditioner status)	Troubleshooting
Wrong wire connection, or poor connection	Check the wiring status according to circuit diagram	Connect wires according to wiring diagram to make sure all wiring terminals are connected firmly
Capacity of the ODU fan motor is damaged	Measure the capacity of fan capacitor with an universal meter and find that the capacity is out of the deviation range indicated on the nameplate of fan capacitor.	Replace the capacity of fan
Power voltage is a little low or high	Use universal meter to measure the power supply voltage. The voltage is a little high or low	Suggest to equip with voltage regulator
Motor of outdoor unit is damaged	When unit is on, cooling/heating performance is bad and ODU compressor generates a lot of noise and heat.	Change compressor oil and refrigerant. If no better, replace the compressor with a new one

5. Compressor Doesn't Operate

Possible causes	Discriminating method (air conditioner status)	Troubleshooting
Wrong wire connection, or poor connection	Check the wiring status according to circuit diagram	Connect wires according to wiring diagram to make sure all wiring terminals are connected firmly
Capacity of compressor is damaged	Measure the capacity of fan capacitor with an universal meter and find that the capacity is out of the deviation range indicated on the nameplate of fan capacitor.	Replace the compressor capacitor
Power voltage is a little low or high	Use universal meter to measure the power supply voltage. The voltage is a little high or low	Suggest to equip with voltage regulator
Coil of compressor is burnt out	Use universal meter to measure the resistance between compressor terminals and it's 0	Repair or replace compressor
Cylinder of compressor is blocked	Compressor can't operate	Repair or replace compressor

6. Air Conditioning Unit is Leaking

Possible causes	Discriminating method (air conditioner status)	Troubleshooting
Condensate pipe is blocked	Water leaking from indoor unit	Eliminate the foreign objects inside the drain pipe
Condensate pipe is broken	Water leaking from drain pipe	Replace condensate pipe
Wrapping is not tight	Water leaking from the pipe connection place of indoor unit	Wrap it again and bundle it tightly

7. Abnormal Sound and Vibration

Possible causes	Discriminating method (air conditioner status)	Troubleshooting
When turn on or turn off the unit, the panel and other parts will expand and there's abnormal sound	There's the sound of "PAPA"	Normal phenomenon. Abnormal sound will disappear after a few minutes.
When turn on or turn off the unit, there's abnormal sound due to flow of refrigerant inside air conditioner	Water-running sound can be heard	Normal phenomenon. Abnormal sound will disappear after a few minutes.
Foreign objects inside the indoor unit or there're parts touching together inside the indoor unit	There's abnormal sound fro indoor unit	Remove foreign objects. Adjust all parts' position of indoor unit, tighten screws and stick damping plaster between connected parts
Foreign objects inside the outdoor unit or there're parts touching together inside the outdoor unit	There's abnormal sound fro outdoor unit	Remove foreign objects. Adjust all parts' position of outdoor unit, tighten screws and stick damping plaster between connected parts
Short circuit inside the magnetic coil	During heating, the way valve has abnormal electromagnetic sound	Replace magnetic coil
Abnormal shake of compressor	Outdoor unit gives out abnormal sound	Adjust the support foot mat of compressor, tighten the bolts
Abnormal sound inside the compressor	Abnormal sound inside the compressor	If too much refrigerant during maintenance, please reduce refrigerant properly. Replace compressor for other circumstances.



8. Removal Procedures

Warning: Be sure to wait for a minimum of 20 minutes after turning off all power supplies and discharge the refrigerant completely before removal.

8.1 Removal Procedures of Indoor Unit

NOTE: Take A6 panel as an example.

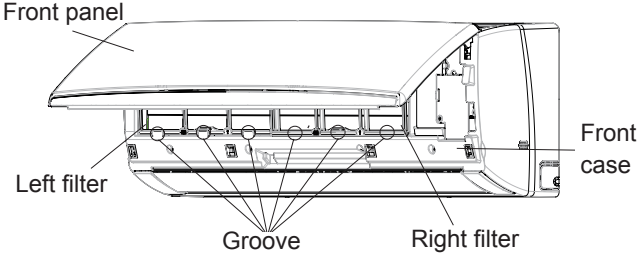
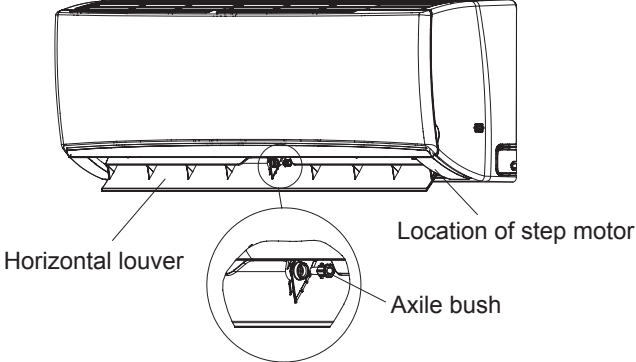
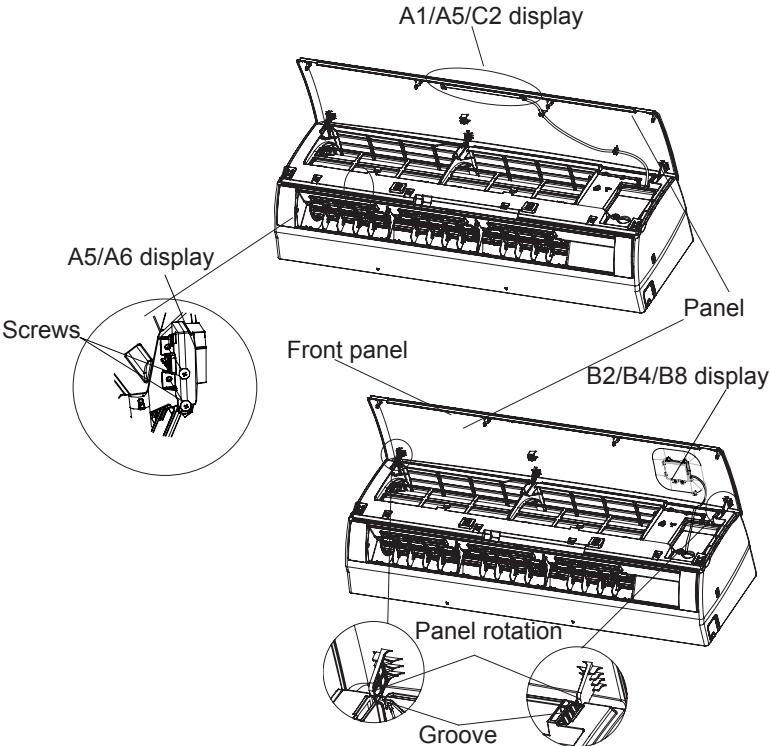
Step	Procedure
<p>1. Remove filter assembly</p> <p>Open the front panel. Push the left filter and right filter until they are separate from the groove on the front panel. Remove the left filter and right filter respectively.</p>	
<p>2. Remove horizontal louver</p> <p>Push out the axle bush on horizontal louver. Bend the horizontal louver by hand and then separate the horizontal louver from the crankshaft of step motor to remove it.</p>	
<p>3. Remove panel</p> <p>a</p> <p>(1)A1/A5/C2 panel display: Screw off the 2 screws that are locking the display board. Separate the display board from the front panel.</p> <p>(2)A5/A6 panel display: Screw off the 2 screws that are locking the display board. Note: This display can be disassembled only after removing the front case (refer to step 5 of disassembly).</p> <p>(3)B2/B4/B8 panel display: Screw off the 2 screws that are locking the display board.</p> <p>b</p> <p>Separate the panel rotation shaft from the groove fixing the front panel and then remove the front panel.</p>	

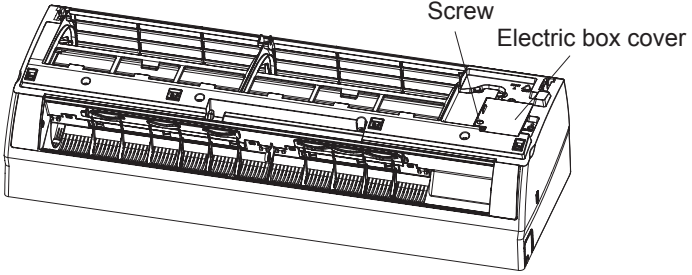
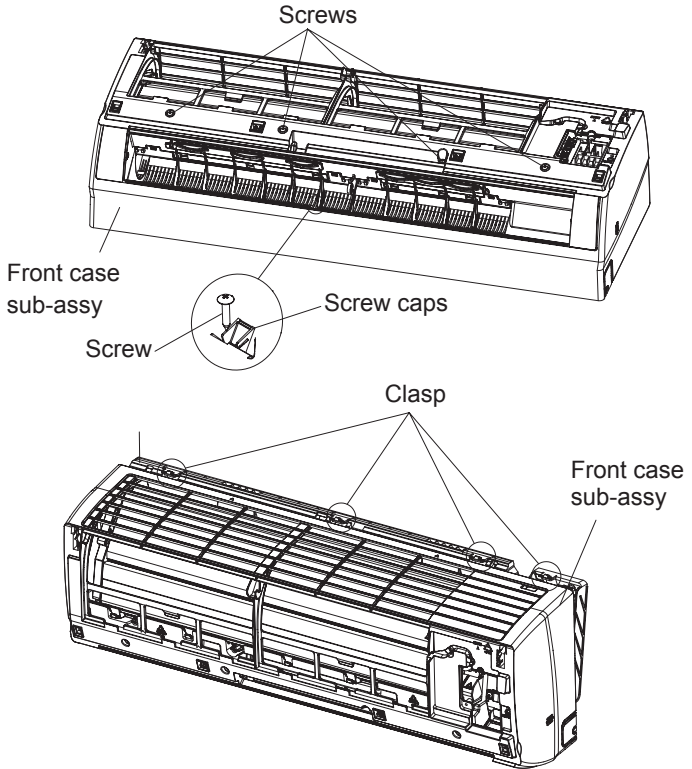
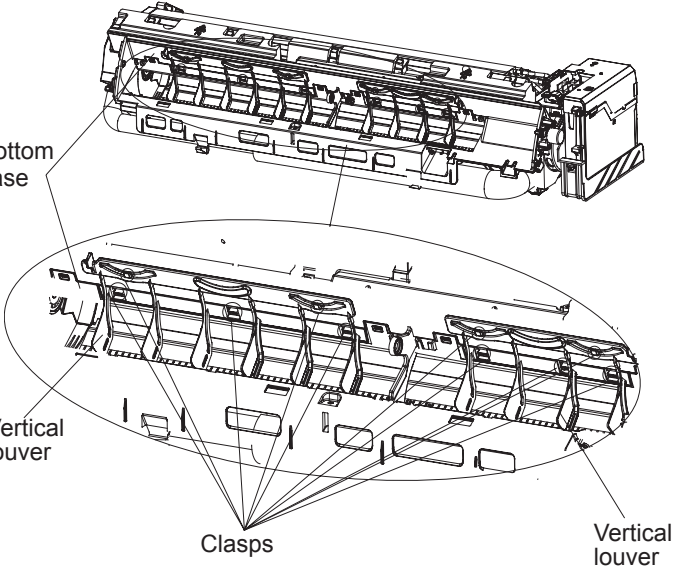

Step	Procedure
4. Remove electric box cover	<p>Remove the screws on the electric box cover to remove the electric box cover.</p> 
5. Remove front case sub-assy	<p>a Remove the screws fixing front case.</p> <p>Note: 1. Open the screw caps before removing the screws around the air outlet. 2. The quantity of screws fixing the front case sub-assy is different for different models.</p> <p>b Loosen the connection clasps between front case sub-assy and bottom case. Lift up the front case sub-assy and take it out.</p> 
6. Remove vertical louver	<p>Loosen the connection clasps between vertical louver and bottom case to remove vertical louver.</p> 

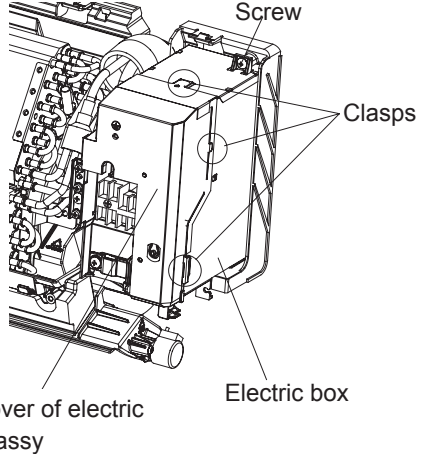
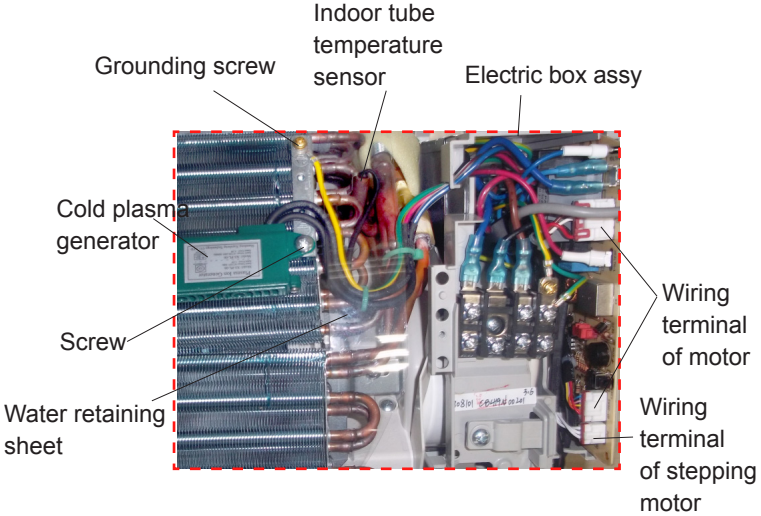
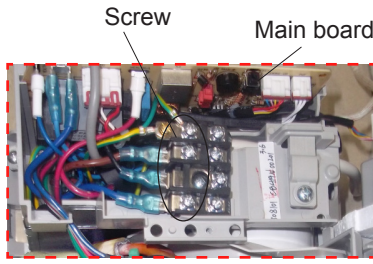
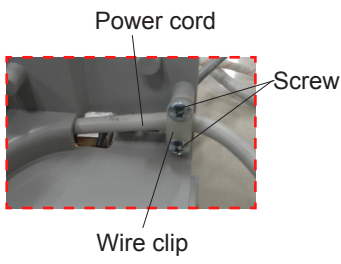

Step	Procedure
7. Remove electric box assy	
a	<p>Loosen the connection clasps between shield cover of electric box sub-assy and electric box, and then remove the shield cover of electric box sub-assy. Remove the screw fixing electric box assy.</p> 
b	<p>① Take off the water retaining sheet. Remove the cold plasma generator by screwing off the locking screw on the generator. ② Take off the indoor tube temperature sensor. ③ Screw off 1 grounding screw. ④ Remove the wiring terminals of motor and stepping motor. ⑤ Remove the electric box assy.</p> 
c	<p>Twist off the screws that are locking each lead wire and rotate the electric box assy. Twist off the screws that are locking the wire clip. Loosen the power cord and remove its wiring terminal. Lift up the main board and take it off.</p>  

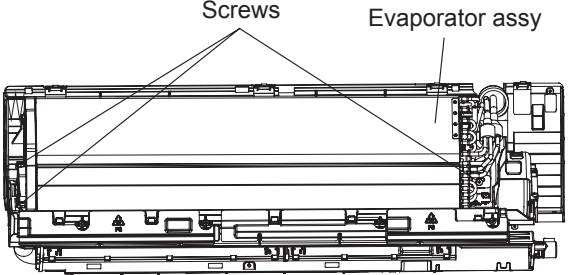
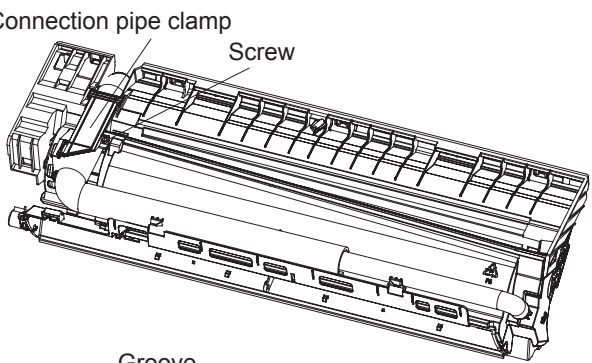
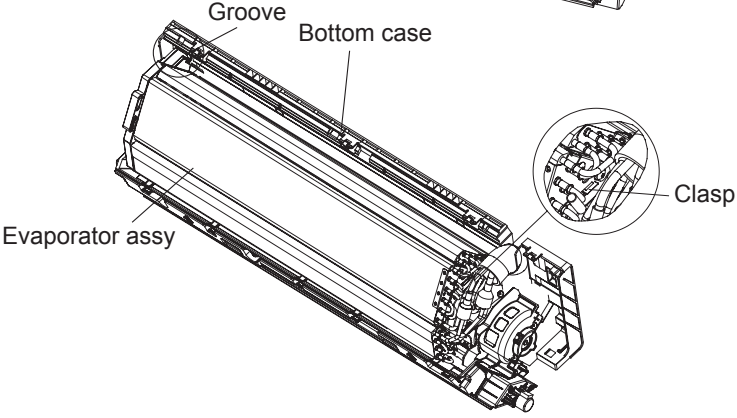
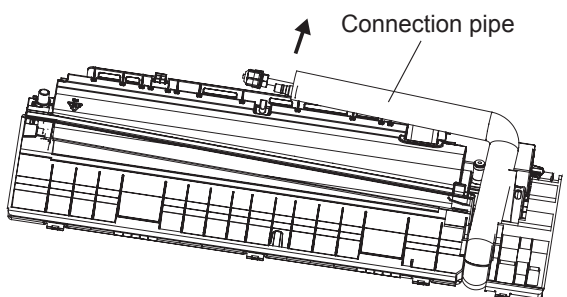
Step	Procedure	Image
	<p>Instruction: Some wiring terminals of this product are with lock catches and other devices. The pulling method is as below:</p> <p>1.Remove the soft sheath for some terminals first, hold the circlip and then pull out the terminals.</p> <p>2.Pull out the holder for some terminals at first (holder is not available for some wiring terminal), hold the connector and then pull the terminal.</p>	 <p>Labels: circlip, soft sheath, holder, connector</p>
<p>8. Remove evaporator assy</p>		
a	<p>Remove 3 screws fixing evaporator assy.</p>	 <p>Labels: Screws, Evaporator assy</p>
b	<p>At the back of the unit, remove the screw fixing connection pipe clamp and then remove the connection pipe clamp.</p>	 <p>Labels: Connection pipe clamp, Screw</p>
c	<p>First remove the left side of the evaporator from the groove of bottom case and then remove the right side from the clasp on the bottom case.</p>	 <p>Labels: Groove, Bottom case, Evaporator assy, Clasp</p>
d	<p>Adjust the position of connection pipe on evaporator slightly and then lift the evaporator upwards to remove it.</p>	 <p>Labels: Connection pipe</p>



8.2 Removal Procedures of Outdoor Unit

⚠ Warning: Be sure to wait for a minimum of 20 minutes after turning off all power supplies and discharge the refrigerant completely before removal.

NOTE: Take heat pump as an example.

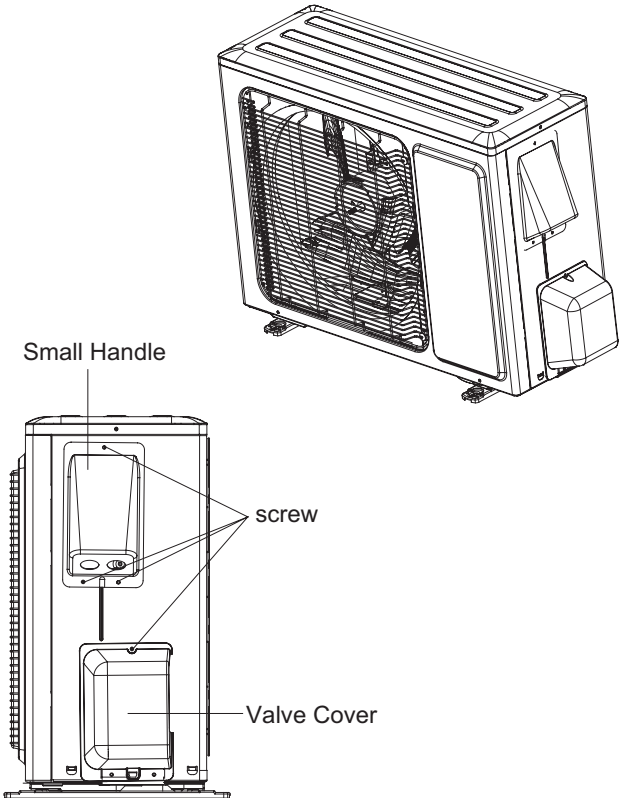
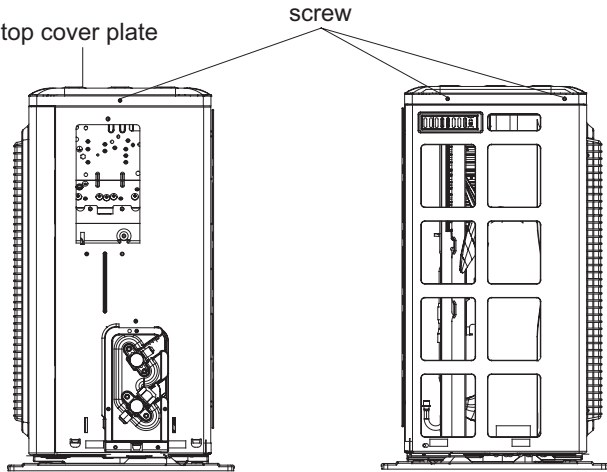
Steps	Procedure
<p>1.Remove big handle</p>	<p>Before disassembling.</p> <p>Remove 3 connection screws fixing small handle and then remove the big handle.</p> <p>Remove 1 connection screw fixing valve cover and then remove the valve cover.</p> 
<p>2. Remove top cover</p>	<p>Remove 3 connection screws among top cover plate, front panel and right side plate. Then remove top cover plate.</p> 

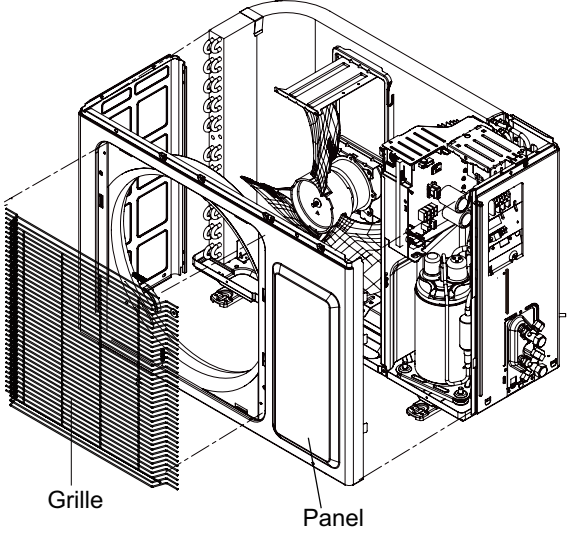
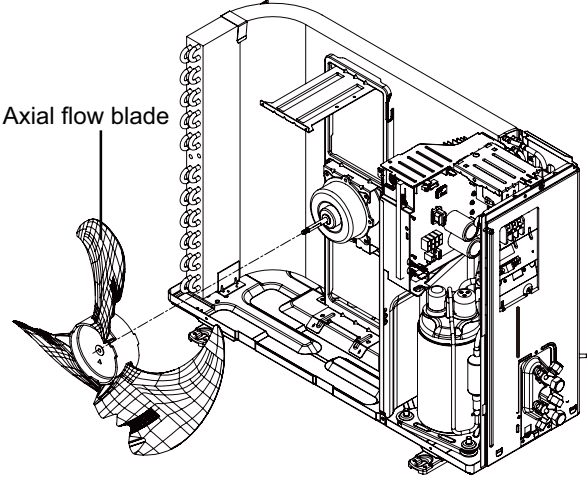
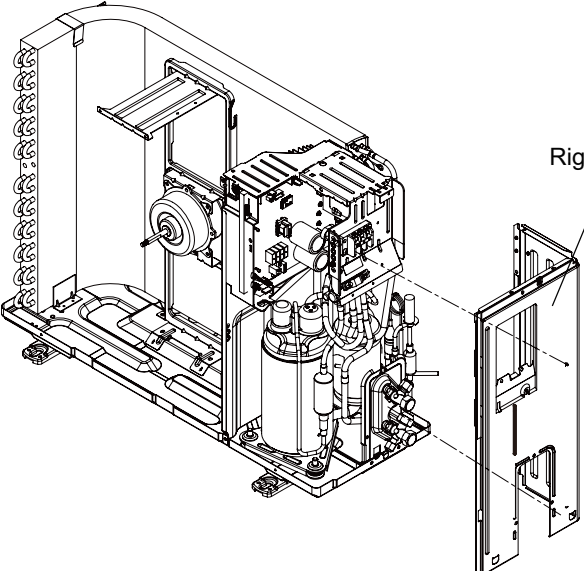

Steps	Procedure
<p>3.Remove grille and front panel</p>	<p>Remove connection screws between the front grille and the front panel. Then remove the front grille. Remove connection screws connecting the front panel with the chassis and the motor support, and then remove the front panel.</p>  <p>Grille</p> <p>Panel</p>
<p>4.Remove axial flow blade</p>	<p>Remove the nut fixing the blade and then remove the axial flow blade.</p>  <p>Axial flow blade</p>
<p>5.Remove right side plate</p>	<p>Remove connection screws connecting the right side plate with the valve support and the electric box. Then remove the right side plate.</p>  <p>Right side plate</p>

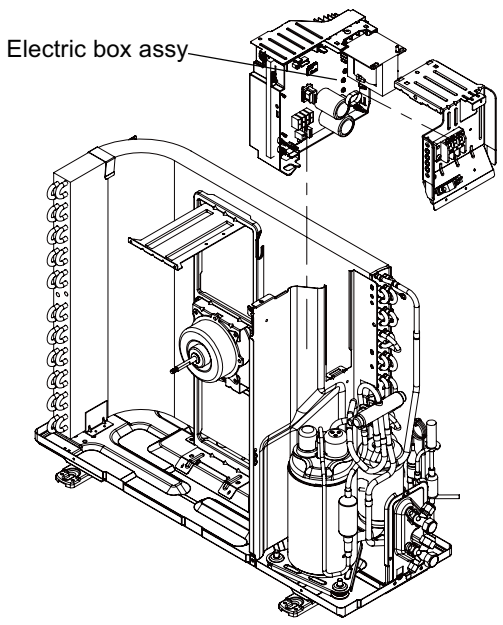
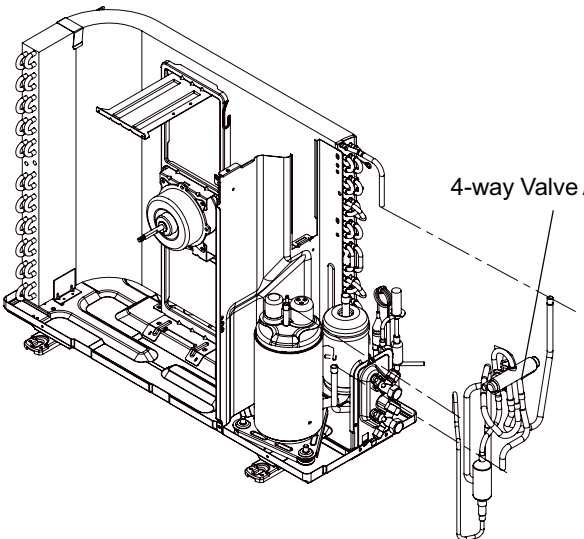
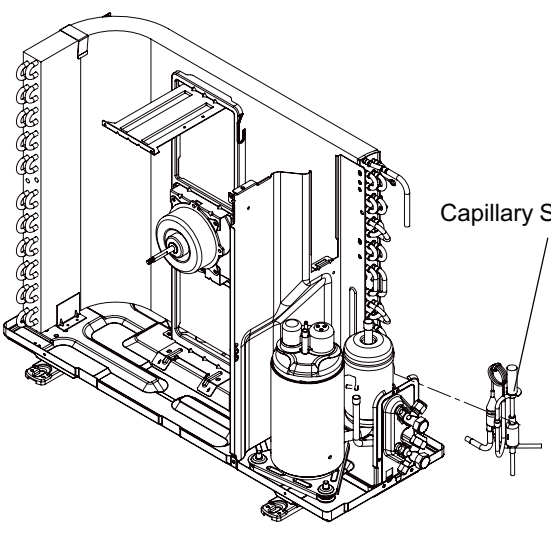
Steps	Procedure
<p>6.Remove electric box assy</p>	<p>Remove the 2 screws fixing the cover of electric box. Lift to remove the cover. Loosen the wire and disconnect the terminal. Lift to remove the electric box assy.</p> 
<p>7.Remove 4-way valve assy</p>	<p>Unscrew the fastening nut of the 4-way Valve Assy coil and remove the coil. Wrap the 4-way Valve Assy with wet cotton and unsolder the 4 weld spots connecting the 4-way Valve Assy to take it out. (Note: Refrigerant should be discharged first.) Welding process should be as quickly as possible and keep wrapping cotton wet all the time. Be sure not to burn out the lead-out wire of compressor.</p> 
<p>8.Remove capillary sub-assy</p>	<p>Unsolder weld point of capillary sub-assy, valve and outlet pipe of condenser. Then remove the capillary sub-assy. Do not block the capillary when unsoldering it. (Note: Before unsoldering, discharge refrigerants completely.)</p> 

Steps	Procedure
11.Remove Compressor	
1	<p>Remove the 2 screws fixing the gas valve. Unsolder the welding spot connecting gas valve and air return pipe and remove the gas valve. (Note: It is necessary to wrap the gas valve when unsoldering the welding spot.) Remove the 2 screws fixing liquid valve. Unsolder the welding spot connecting liquid valve and remove the liquid valve.</p>
2	<p>Remove the 3 footing screws of the compressor and remove the compressor.</p>

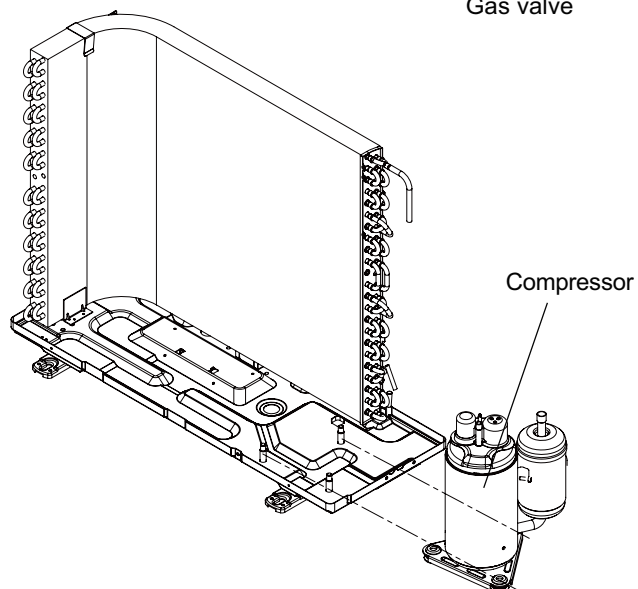
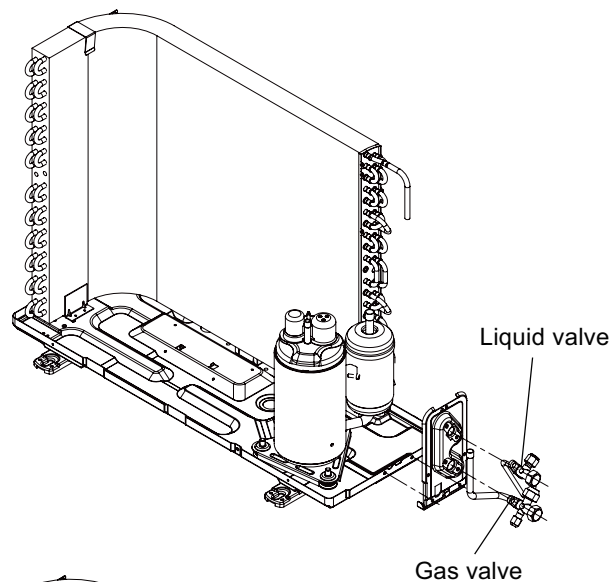

Appendix:

Appendix 1: Reference Sheet of Celsius and Fahrenheit

Conversion formula for Fahrenheit degree and Celsius degree: $T_f = T_c \times 1.8 + 32$

Set temperature

Fahrenheit display temperature (°F)	Fahrenheit (°F)	Celsius (°C)	Fahrenheit display temperature (°F)	Fahrenheit (°F)	Celsius (°C)	Fahrenheit display temperature (°F)	Fahrenheit (°F)	Celsius (°C)
61	60.8	16	69/70	69.8	21	78/79	78.8	26
62/63	62.6	17	71/72	71.6	22	80/81	80.6	27
64/65	64.4	18	73/74	73.4	23	82/83	82.4	28
66/67	66.2	19	75/76	75.2	24	84/85	84.2	29
68	68	20	77	77	25	86	86	30

Ambient temperature

Fahrenheit display temperature (°F)	Fahrenheit (°F)	Celsius (°C)	Fahrenheit display temperature (°F)	Fahrenheit (°F)	Celsius (°C)	Fahrenheit display temperature (°F)	Fahrenheit (°F)	Celsius (°C)
32/33	32	0	55/56	55.4	13	79/80	78.8	26
34/35	33.8	1	57/58	57.2	14	81	80.6	27
36	35.6	2	59/60	59	15	82/83	82.4	28
37/38	37.4	3	61/62	60.8	16	84/85	84.2	29
39/40	39.2	4	63	62.6	17	86/87	86	30
41/42	41	5	64/65	64.4	18	88/89	87.8	31
43/44	42.8	6	66/67	66.2	19	90	89.6	32
45	44.6	7	68/69	68	20	91/92	91.4	33
46/47	46.4	8	70/71	69.8	21	93/94	93.2	34
48/49	48.2	9	72	71.6	22	95/96	95	35
50/51	50	10	73/74	73.4	23	97/98	96.8	36
52/53	51.8	11	75/76	75.2	24	99	98.6	37
54	53.6	12	77/78	77	25			

Appendix 2: Configuration of Connection Pipe

1. Standard length of connection pipe

- 16.40ft, 24.61ft, 26.25ft.

2. Min. length of connection pipe is 9.84ft.

3. Max. length of connection pipe and max. high difference.

4. The additional refrigerant oil and refrigerant charging required after prolonging connection pipe

- After the length of connection pipe is prolonged for 32.81ft at the basis of standard length, you should add 0.0013gal of refrigerant oil for each additional 16.40ft of connection pipe.

- The calculation method of additional refrigerant charging amount (on the basis of liquid pipe):

Cooling capacity	Max length of connection pipe	Max height difference
5000 Btu/h(1465 W)	49.21ft	16.40ft
7000 Btu/h(2051 W)	49.21ft	16.40ft
9000 Btu/h(2637 W)	49.21ft	32.81ft
12000 Btu/h(3516 W)	65.62ft	32.81ft
18000 Btu/h(5274 W)	82.02ft	32.81ft
24000 Btu/h(7032 W)	82.02ft	32.81ft
28000 Btu/h(8204 W)	98.43ft	32.81ft
36000 Btu/h(10548 W)	98.43ft	65.62ft
42000 Btu/h(12306 W)	98.43ft	65.62ft
48000 Btu/h(14064 W)	98.43ft	65.62ft

- When the length of connection pipe is above 16.40ft, add refrigerant according to the prolonged length of liquid pipe. The additional refrigerant charging amount per meter is different according to the diameter of liquid pipe. See the following sheet.

- Additional refrigerant charging amount = prolonged length of liquid pipe X additional refrigerant charging amount per meter

Additional refrigerant charging amount for R22, R407C, R410A and R134a			
Diameter of connection pipe		Outdoor unit throttle	
Liquid pipe(inch)	Gas pipe(inch)	Cooling only(oz/ft.)	Cooling and heating(oz/ft.)
Φ0.24	Φ0.37 or Φ0.47	0.2	0.2
Φ0.24 or Φ0.37	Φ0.63 or Φ0.75	0.2	0.2
Φ0.47	Φ0.75 or Φ0.87	0.3	1.3
Φ0.63	Φ1 or Φ1.25	0.7	1.3
Φ0.75	/	2.7	2.7
Φ0.87	/	3.8	3.8



Appendix 3: Pipe Flaring Method

⚠ Note:

Improper pipe flaring is the main cause of refrigerant leakage. Please flare the pipe according to the following steps:

A: Cut the pipe

- Confirm the pipe length according to the distance of indoor unit and outdoor unit.
- Cut the required pipe with pipe cutter.

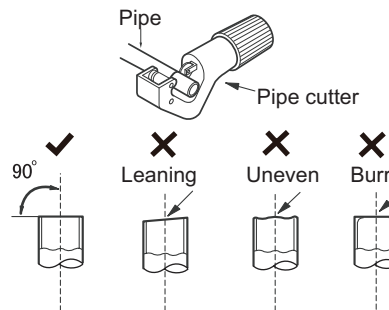

B: Remove the burrs

- Remove the burrs with shaper and prevent the burrs from getting into the pipe.

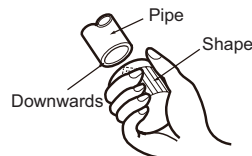

C: Put on suitable insulating pipe

D: Put on the union nut

- Remove the union nut on the indoor connection pipe and outdoor valve; install the union nut on the pipe.

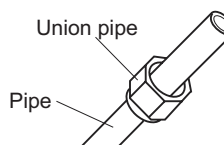

E: Flare the pipe

- Flare the pipe with expander.

⚠ Note:

- "A" is different according to the diameter, please refer to the sheet below:

Outer diameter(inch)	A(inch)	
	Max	Min
Φ0.24 - 0.25 (1/4")	0.05	0.03
Φ0.37 (3/8")	0.06	0.04
Φ0.47 - 0.50 (1/2")	0.07	0.04
Φ0.63 - 0.625 (5/8")	0.09	0.09

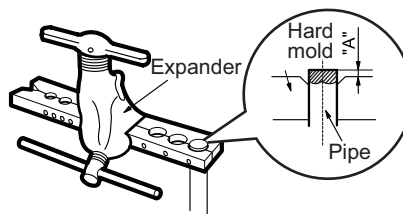

F: Inspection

- Check the quality of flaring port. If there is any blemish, flare the port again according to the steps above.

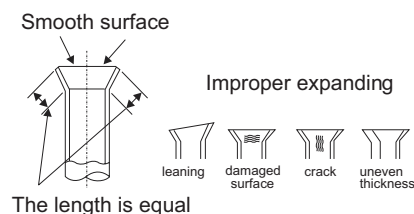

Appendix 4: List of Resistance for Temperature Sensor

Resistance Table of Ambient Temperature Sensor for Indoor and Outdoor(15K)

Temp.(°F)	Resistance(kΩ)	Temp.(°F)	Resistance(kΩ)	Temp.(°F)	Resistance(kΩ)	Temp.(°F)	Resistance(kΩ)
-2.2	138.1	68	18.75	138.2	3.848	208.4	1.071
-0.4	128.6	69.8	17.93	140	3.711	210.2	1.039
1.4	121.6	71.6	17.14	141.8	3.579	212	1.009
3.2	115	73.4	16.39	143.6	3.454	213.8	0.98
5	108.7	75.2	15.68	145.4	3.333	215.6	0.952
6.8	102.9	77	15	147.2	3.217	217.4	0.925
8.6	97.4	78.8	14.36	149	3.105	219.2	0.898
10.4	92.22	80.6	13.74	150.8	2.998	221	0.873
12.2	87.35	82.4	13.16	152.6	2.896	222.8	0.848
14	82.75	84.2	12.6	154.4	2.797	224.6	0.825
15.8	78.43	86	12.07	156.2	2.702	226.4	0.802
17.6	74.35	87.8	11.57	158	2.611	228.2	0.779
19.4	70.5	89.6	11.09	159.8	2.523	230	0.758
21.2	66.88	91.4	10.63	161.6	2.439	231.8	0.737
23	63.46	93.2	10.2	163.4	2.358	233.6	0.717
24.8	60.23	95	9.779	165.2	2.28	235.4	0.697
26.6	57.18	96.8	9.382	167	2.206	237.2	0.678
28.4	54.31	98.6	9.003	168.8	2.133	239	0.66
30.2	51.59	100.4	8.642	170.6	2.064	240.8	0.642
32	49.02	102.2	8.297	172.4	1.997	242.6	0.625
33.8	46.6	104	7.967	174.2	1.933	244.4	0.608
35.6	44.31	105.8	7.653	176	1.871	246.2	0.592
37.4	42.14	107.6	7.352	177.8	1.811	248	0.577
39.2	40.09	109.4	7.065	179.6	1.754	249.8	0.561
41	38.15	111.2	6.791	181.4	1.699	251.6	0.547
42.8	36.32	113	6.529	183.2	1.645	253.4	0.532
44.6	34.58	114.8	6.278	185	1.594	255.2	0.519
46.4	32.94	116.6	6.038	186.8	1.544	257	0.505
48.2	31.38	118.4	5.809	188.6	1.497	258.8	0.492
50	29.9	120.2	5.589	190.4	1.451	260.6	0.48
51.8	28.51	122	5.379	192.2	1.408	262.4	0.467
53.6	27.18	123.8	5.197	194	1.363	264.2	0.456
55.4	25.92	125.6	4.986	195.8	1.322	266	0.444
57.2	24.73	127.4	4.802	197.6	1.282	267.8	0.433
59	23.6	129.2	4.625	199.4	1.244	269.6	0.422
60.8	22.53	131	4.456	201.2	1.207	271.4	0.412
62.6	21.51	132.8	4.294	203	1.171	273.2	0.401
64.4	20.54	134.6	4.139	204.8	1.136	275	0.391
66.2	19.63	136.4	3.99	206.6	1.103	276.8	0.382

Resistance Table of Tube Temperature Sensors for Indoor and Outdoor (20K)

Temp.(°F)	Resistance(kΩ)	Temp.(°F)	Resistance(kΩ)	Temp.(°F)	Resistance(kΩ)	Temp.(°F)	Resistance(kΩ)
-2.2	181.4	68	25.01	138.2	5.13	208.4	1.427
-0.4	171.4	69.8	23.9	140	4.948	210.2	1.386
1.4	162.1	71.6	22.85	141.8	4.773	212	1.346
3.2	153.3	73.4	21.85	143.6	4.605	213.8	1.307
5	145	75.2	20.9	145.4	4.443	215.6	1.269
6.8	137.2	77	20	147.2	4.289	217.4	1.233
8.6	129.9	78.8	19.14	149	4.14	219.2	1.198
10.4	123	80.6	18.13	150.8	3.998	221	1.164
12.2	116.5	82.4	17.55	152.6	3.861	222.8	1.131
14	110.3	84.2	16.8	154.4	3.729	224.6	1.099
15.8	104.6	86	16.1	156.2	3.603	226.4	1.069
17.6	99.13	87.8	15.43	158	3.481	228.2	1.039
19.4	94	89.6	14.79	159.8	3.364	230	1.01
21.2	89.17	91.4	14.18	161.6	3.252	231.8	0.983
23	84.61	93.2	13.59	163.4	3.144	233.6	0.956
24.8	80.31	95	13.04	165.2	3.04	235.4	0.93
26.6	76.24	96.8	12.51	167	2.94	237.2	0.904
28.4	72.41	98.6	12	168.8	2.844	239	0.88
30.2	68.79	100.4	11.52	170.6	2.752	240.8	0.856
32	65.37	102.2	11.06	172.4	2.663	242.6	0.833
33.8	62.13	104	10.62	174.2	2.577	244.4	0.811
35.6	59.08	105.8	10.2	176	2.495	246.2	0.77
37.4	56.19	107.6	9.803	177.8	2.415	248	0.769
39.2	53.46	109.4	9.42	179.6	2.339	249.8	0.746
41	50.87	111.2	9.054	181.4	2.265	251.6	0.729
42.8	48.42	113	8.705	183.2	2.194	253.4	0.71
44.6	46.11	114.8	8.37	185	2.125	255.2	0.692
46.4	43.92	116.6	8.051	186.8	2.059	257	0.674
48.2	41.84	118.4	7.745	188.6	1.996	258.8	0.658
50	39.87	120.2	7.453	190.4	1.934	260.6	0.64
51.8	38.01	122	7.173	192.2	1.875	262.4	0.623
53.6	36.24	123.8	6.905	194	1.818	264.2	0.607
55.4	34.57	125.6	6.648	195.8	1.736	266	0.592
57.2	32.98	127.4	6.403	197.6	1.71	267.8	0.577
59	31.47	129.2	6.167	199.4	1.658	269.6	0.563
60.8	30.04	131	5.942	201.2	1.609	271.4	0.549
62.6	28.68	132.8	5.726	203	1.561	273.2	0.535
64.4	27.39	134.6	5.519	204.8	1.515	275	0.521
66.2	26.17	136.4	5.32	206.6	1.47	276.8	0.509

Resistance Table of Discharge Temperature Sensor for Outdoor(50K)

Temp.(°F)	Resistance(kΩ)	Temp.(°F)	Resistance(kΩ)	Temp.(°F)	Resistance(kΩ)	Temp.(°F)	Resistance(kΩ)
-20.2	853.5	50	98	120.2	18.34	190.4	4.754
-18.4	799.8	51.8	93.42	122	17.65	192.2	4.609
-16.6	750	53.6	89.07	123.8	16.99	194	4.469
-14.8	703.8	55.4	84.95	125.6	16.36	195.8	4.334
-13	660.8	57.2	81.05	127.4	15.75	197.6	4.204
-11.2	620.8	59	77.35	129.2	15.17	199.4	4.079
-9.4	580.6	60.8	73.83	131	14.62	201.2	3.958
-7.6	548.9	62.6	70.5	132.8	14.09	203	3.841
-5.8	516.6	64.4	67.34	134.6	13.58	204.8	3.728
-4	486.5	66.2	64.33	136.4	13.09	206.6	3.619
-2.2	458.3	68	61.48	138.2	12.62	208.4	3.514
-0.4	432	69.8	58.77	140	12.17	210.2	3.413
1.4	407.4	71.6	56.19	141.8	11.74	212	3.315
3.2	384.5	73.4	53.74	143.6	11.32	213.8	3.22
5	362.9	75.2	51.41	145.4	10.93	215.6	3.129
6.8	342.8	77	49.19	147.2	10.54	217.4	3.04
8.6	323.9	78.8	47.08	149	10.18	219.2	2.955
10.4	306.2	80.6	45.07	150.8	9.827	221	2.872
12.2	289.6	82.4	43.16	152.6	9.489	222.8	2.792
14	274	84.2	41.34	154.4	9.165	224.6	2.715
15.8	259.3	86	39.61	156.2	8.854	226.4	2.64
17.6	245.6	87.8	37.96	158	8.555	228.2	2.568
19.4	232.6	89.6	36.38	159.8	8.268	230	2.498
21.2	220.5	91.4	34.88	161.6	7.991	231.8	2.431
23	209	93.2	33.45	163.4	7.726	233.6	2.365
24.8	198.3	95	32.09	165.2	7.47	235.4	2.302
26.6	199.1	96.8	30.79	167	7.224	237.2	2.241
28.4	178.5	98.6	29.54	168.8	6.998	239	2.182
30.2	169.5	100.4	28.36	170.6	6.761	240.8	2.124
32	161	102.2	27.23	172.4	6.542	242.6	2.069
33.8	153	104	26.15	174.2	6.331	244.4	2.015
35.6	145.4	105.8	25.11	176	6.129	246.2	1.963
37.4	138.3	107.6	24.13	177.8	5.933	248	1.912
39.2	131.5	109.4	23.19	179.6	5.746	249.8	1.863
41	125.1	111.2	22.29	181.4	5.565	251.6	1.816
42.8	119.1	113	21.43	183.2	5.39	253.4	1.77
44.6	113.4	114.8	20.6	185	5.222	255.2	1.725
46.4	108	116.6	19.81	186.8	5.06	257	1.682
48.2	102.8	118.4	19.06	188.6	4.904	258.8	1.64

Support Contact Information:

	Phone	Email
Technical Support Support during installation, commissioning, service and troubleshooting	1(844) 873-4443	BE-VRFTechSupport@jci.com
Applications and Design Presale assistance with equip applications and design support, as well as use of selection tool	1(844) 873-6755	BE-VRFApplicationDesign@jci.com
Customer Service Assistance ordering equipment, parts and accessories	1(844) 873-4445	BE-VRFCustomerService@jci.com
Warranty Assistance with warranty registration, warranty claims, etc.	1(844) 873-9768	BE-VRFWarranty@jci.com
Parts Equipment and parts pre- and post-sale support	1(844) 873-4445	BE-VRFParts@jci.com

Product improvement, specifications and appearance in this manual are subject to change without prior notice.